

Y SERIES

<http://www.noritake-elec.com/y-series.htm>



ISO 9001 and ISO 14000 Certified

16 x 2 LCD footprint

CU22042-Y1A / 100

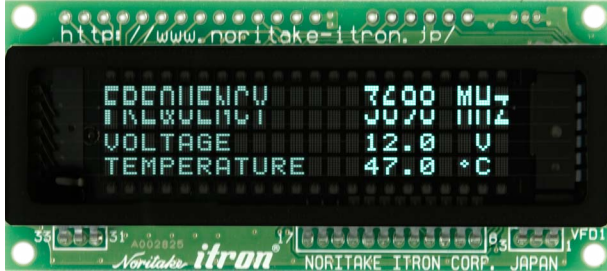

Character number comparison

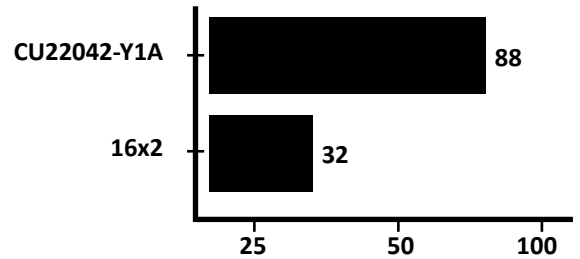

20 x 2 LCD footprint

CU20027-YX1A

CU20027-Y1A / Y100



Brightness comparison (Cd/m²)

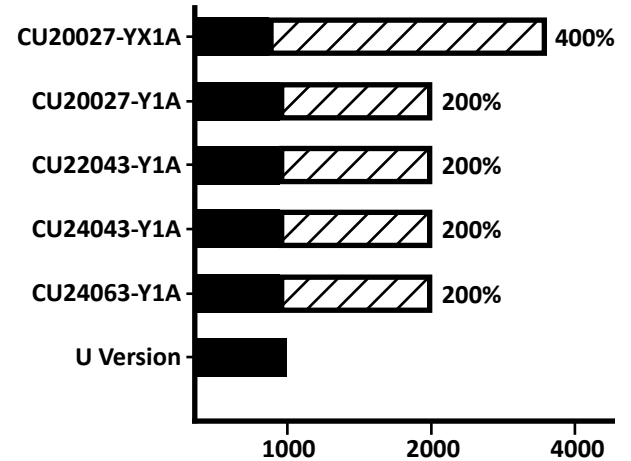

CU24043-Y1A / Y100



Character number comparison

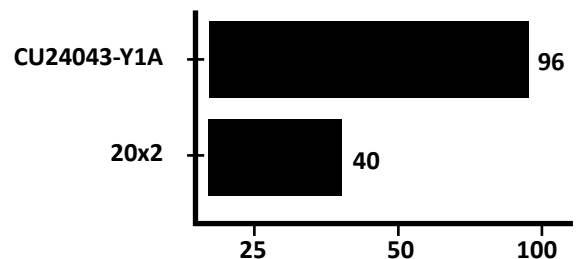

20 x 4 LCD footprint

CU24063-Y1A / Y100

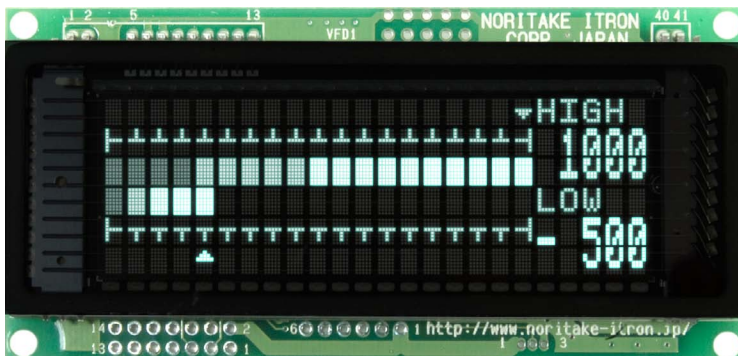

Character number comparison

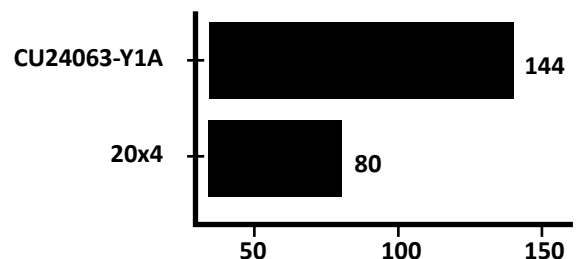

New to the Y Series

CU22042-Y1A

22x4 characters in 16x2 LCD footprint.

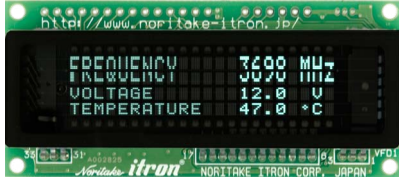

CU20027-YX1A

20x2 LCD footprint and brightest Vacuum Fluorescent Display (VFD) module from Noritake Itron.



Features

- Easy command set
- 2x the brightness with the brightness boost
- Highlight character
- 16 UDF and 1 custom font table
- 14 International font tables and 10 extended ASCII
- Select from 1x1, 1x2, and 2x2 character sizes
- More characters in compact display size
- 1U rack height models available
- Available in i80 8-bit parallel, asynchronous serial, synchronous serial, and async RS232 interfaces
- Reliability in all environmental conditions
- Wide temperature range of -40°C up to +85°C

Evaluation kits available

Visit our online shop for Y Series evaluation kits:
noritake-vfd.com/yseries.aspx

Available interfaces

8 bit parallel interface (i80 type)

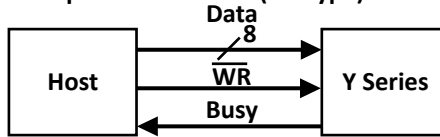

Async serial interface

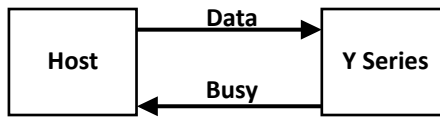

Sync serial interface

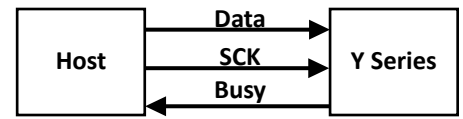

Block Diagram

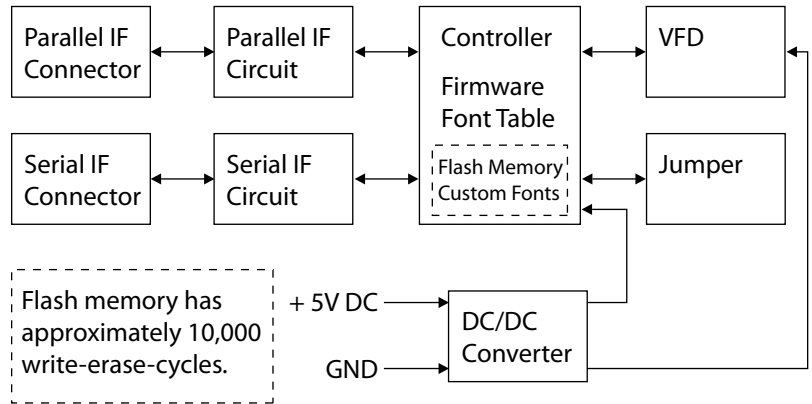

Value Added Services

Let us pre-assemble the connectors, cables, color filter, and/or conformal coating with your VFD.

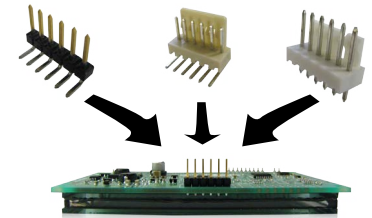
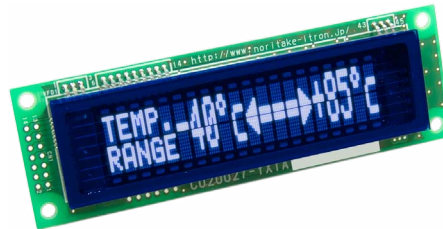

VFD module with color filter

Part Number	Number of Characters	Character Height (mm)	Display Size (mm)	PCB Size (mm)	Interface	Power Supply Typical
CU20027-Y1A	20 x 2	7	73.4 x 15.0	116.0 x 37.0	i80 8-bit Parallel (5V CMOS) Async Serial (5V CMOS) Sync Serial (5V CMOS)	5 V / 240 mA
New CU22042-Y1A	22 x 4	2	52.5 x 11.5	80.0 x 36.0		5 V / 180 mA
CU24043-Y1A	24 x 4	3	73.4 x 15.0	116.0 x 37.0		5 V / 220 mA
CU24063-Y1A	24 x 6	3	70.4 x 22.7	98.0 x 47.0		5 V / 320 mA
New CU20027-YX1A	20 x 2	7	73.4 x 15.0	116.0 x 37.0		5 V / 230 mA
New CU200211-Y1A	20 x 2	11	159.0 x 23.6	190.0 x 55.0		5 V / 720 mA
CU20027-Y100	20 x 2	7	73.4 x 15.0	116.0 x 37.0	i80 8-bit Parallel (5V CMOS) Async Serial (RS232)	5 V / 240 mA
New CU22042-Y100	22 x 4	2	52.5 x 11.5	80.0 x 36.0		5 V / 180 mA
CU24043-Y100	24 x 4	3	73.4 x 15.0	116.0 x 37.0		5 V / 220 mA
CU24063-Y100	24 x 6	3	70.4 x 22.7	98.0 x 47.0		5 V / 320 mA
New CU200211-Y100	20 x 2	11	159.0 x 23.6	190.0 x 55.0		5 v / 720 mA

Noritake Co., Inc.

Electronics Division Headquarter
2635 Clearbrook Drive
Arlington Heights, IL 60005
Toll free: (800) 779 - 5846
Phone: (847) 439 - 9020
support.ele@noritake.com
www.noritake-elec.com

East Coast

New Jersey Branch
15-22 Fair Lawn Ave.
Fair Lawn, NJ 07410
Toll free: (888) 296 - 3423
Phone: (201) 475 - 5200
Fax: (201) 796 - 2269

Midwest, Canada, and Mexico

Chicago Branch
2635 Clearbrook Dr.
Arlington Heights, IL 60005
Toll free: (800) 779 - 5846
Phone: (847) 439 - 9020
Fax: (847) 593 - 2285

West Coast

Los Angeles Branch
21081 S. Western Ave. Ste 180
Torrance, CA 90501
Toll free: (888) 795 - 3423
Phone: (310) 320 - 1700
Fax: (310) 320 - 2900

Noritake itron
The brighter side of electronics

E-M1-0001-09

AMEYA360

Components Supply Platform

Authorized Distribution Brand :



Website :

Welcome to visit www.ameya360.com

Contact Us :

➤ Address :

401 Building No.5, JiuGe Business Center, Lane 2301, Yishan Rd
Minhang District, Shanghai , China

➤ Sales :

Direct +86 (21) 6401-6692

Email amall@ameya360.com

QQ 800077892

Skype [ameyasales1](#) [ameyasales2](#)

➤ Customer Service :

Email service@ameya360.com

➤ Partnership :

Tel +86 (21) 64016692-8333

Email mkt@ameya360.com