

# 4.7 X 4.1 X 1.2 mm INDUSTRIAL GRADE CERAMIC RESONATOR

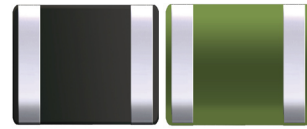

4.7 x 4.1 mm

**AWSZT-MWD**

**RoHS/RoHS II Compliant**  
Pb in ceramic, exemption (7c-I)

## FEATURES:

- Low resonant impedance
- IR reflow capable
- Low cost

## APPLICATION:

- Remote controls, Microprocessor clocks, Mobile phones, DVD & CD-Roms, Electric appliances
- Consumer electronics

## ELECTRICAL SPECIFICATIONS:

Parameters	Minimum	Typical	Maximum	Units	Notes
Frequency Range	6.00		13.00	MHz	
Resonant Impedance (Ro)			30	$\Omega$	
Load Capacitance (C1=C2, for test circuit)	24	30	36	pF	
Frequency Tolerance @25 °C	-0.5		+0.5	%	
Frequency Stability (-25°C to +85°C)	-0.4		+0.4	%	
Withstanding Voltage		50		V	DC, 1 min
Rating Voltage	(1) D.C. Voltage		+6	V	
	(2) A.C. Voltage		15	Vp-p.	
Insulation Resistance	100			M $\Omega$	10V, 1min
Operation Temperature	-25		+85	°C	
Storage Temperature	-55		+85	°C	
Aging Rate (Fosc) (10 years)	-0.3		+0.3	%	

## OPTIONS AND PART IDENTIFICATION:

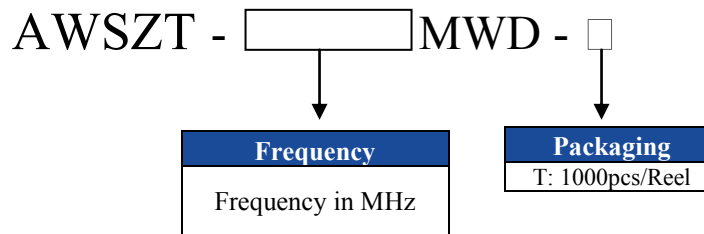

## TEST CONDITIONS AND TEST CIRCUIT

Parts shall be measured under a condition (Temp.: 20±15°C, Humidity: 65±20% R.H.) unless the standard condition (Temp.: 25±3°C, Humidity: 65±5% R.H.) is regulated to test.

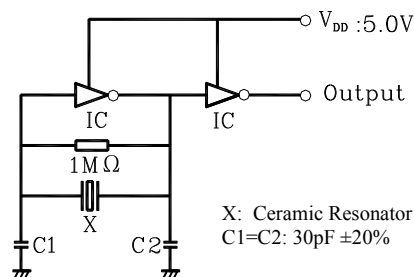

# 4.7 X 4.1 X 1.2 mm INDUSTRIAL GRADE CERAMIC RESONATOR

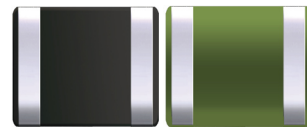

4.7 x 4.1 mm

**AWSZT-MWD**

**RoHS/RoHS II Compliant**  
Pb in ceramic, exemption (7c-I)

## OUTLINE DIMENSION:

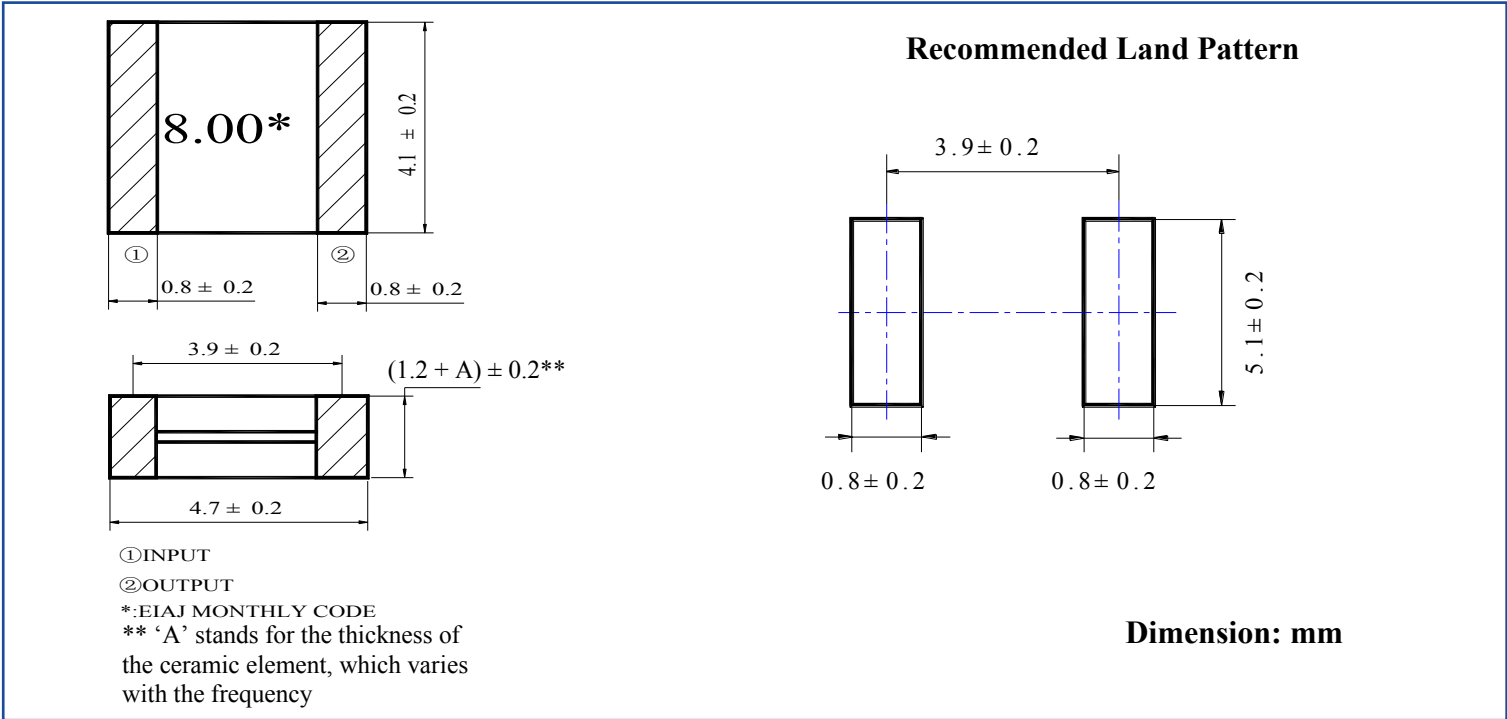

## SUGGESTED REFLOW PROFILE

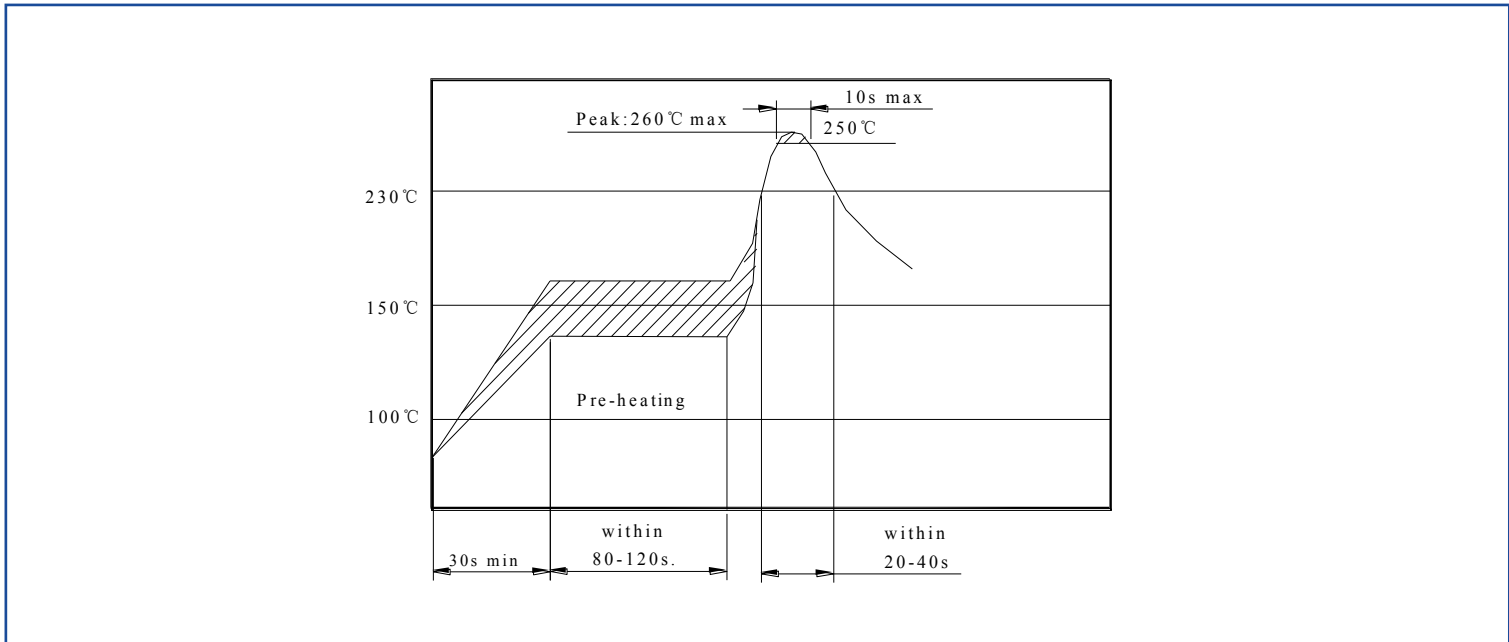

# 4.7 X 4.1 X 1.2 mm INDUSTRIAL GRADE CERAMIC RESONATOR



4.7 x 4.1 mm

**AWSZT-MWD**

**RoHS/RoHS II Compliant**  
Pb in ceramic, exemption (7c-I)

## TAPE & REEL:

**Packaging:**  
**T: 1000pcs/Reel**

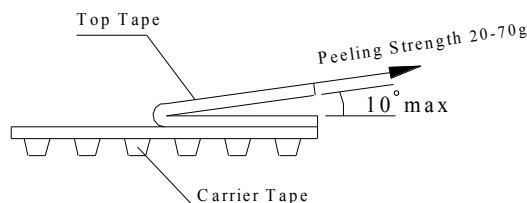
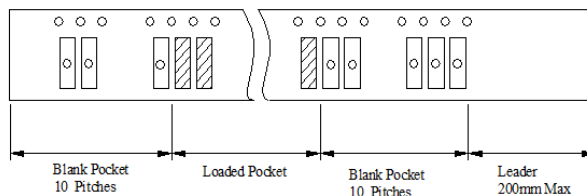
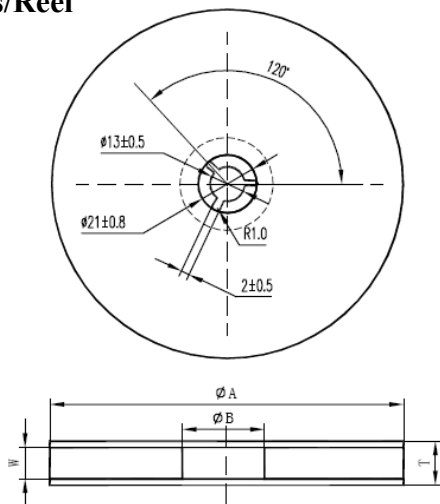

ΦA	ΦB	W	T	Pieces per reel	Carrier tape size
180±3	60 min.	12.4 min	19.4 max	1000 typ.	12

**Dimensions: mm**

**Note: upon opening the original packaging, it is recommended that the product be used within 1 year. If the product will not be used within 1 year, it is recommended that the product be re-sealed in airtight packaging according to MSL 1 requirements to maintain solderability.**

## CAUTION

- (1) Do not apply excess mechanical stress to the component body or terminations. Do not attempt to re-form or bend the components as this will cause damage to the component.
- (2) This component is not hermetically sealed. Do not clean or wash the component.
- (3) Reflow Soldering: Do not use strong acidity flux, such as flux with chlorine content of greater than 0.2wt% during Reflow Soldering.
- (4) Do not expose the component to open flame.
- (5) This specification applies to the functionality of the component as a single unit.
- (6) Storage Conditions: If the product is to be stored for a period greater than 1 year after the Delivery Date, it is recommended that customers confirm the solderability and characteristics for the product prior to use.
- (7) This product is not recommended for use in the following applications: Automotive, Medical, Military, Safety, or any other high-reliability life dependant applications. Contact Abracon Corporation prior to using this product when in doubt.

**ATTENTION:** Abracon Corporation's products are COTS – Commercial-Off-The-Shelf products; suitable for Commercial, Industrial and, where designated, Automotive Applications. Abracon's products are not specifically designed for Military, Aviation, Aerospace, Life-dependant Medical applications or any application requiring high reliability where component failure could result in loss of life and/or property. For applications requiring high reliability and/or presenting an extreme operating environment, written consent and authorization from Abracon Corporation is required. Please contact Abracon Corporation for more information.

ABRACON IS  
ISO9001:2008  
CERTIFIED



Visit [www.abracon.com](http://www.abracon.com) for Terms & Conditions of Sale **Revised: 05.09.13**  
30332 Esperanza, Rancho Santa Margarita, California 92688  
tel 949-546-8000 | fax 949-546-8001 | [www.abracon.com](http://www.abracon.com)

# AMEYA360

## Components Supply Platform

Authorized Distribution Brand :



Website :

Welcome to visit [www.ameya360.com](http://www.ameya360.com)

Contact Us :

➤ Address :

401 Building No.5, JiuGe Business Center, Lane 2301, Yishan Rd  
Minhang District, Shanghai , China

➤ Sales :

Direct +86 (21) 6401-6692

Email [amall@ameya360.com](mailto:amall@ameya360.com)

QQ 800077892

Skype [ameyasales1](#) [ameyasales2](#)

➤ Customer Service :

Email [service@ameya360.com](mailto:service@ameya360.com)

➤ Partnership :

Tel +86 (21) 64016692-8333

Email [mkt@ameya360.com](mailto:mkt@ameya360.com)