

## CDBU0130R-HF

$I_o = 100\text{mA}$

$V_R = 30\text{ Volts}$

RoHS Device

Halogen Free



### Features

- Low reverse current.
- Designed for mounting on small surface.
- Extremely thin / leadless package.
- Majority carrier conduction.

### Mechanical data

- Case: 0603/SOD-523F standard package, molded plastic.
- Terminals: Gold plated, solderable per MIL-STD-750, method 2026.
- Marking code: cathode band & BQ
- Mounting position: Any
- Weight: 0.003 gram(approx.).

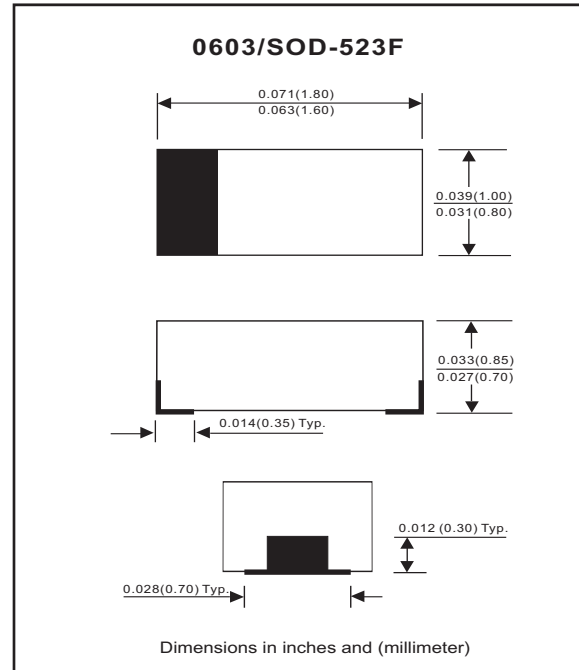

### Maximum Rating (at $T_A=25^\circ\text{C}$ unless otherwise noted)

Parameter	Conditions	Symbol	Min	Typ	Max	Unit
Repetitive peak reverse voltage		$V_{RRM}$			35	V
Reverse voltage		$V_R$			30	V
Average forward current		$I_o$			100	mA
Forward current,surge peak	8.3ms single half sine-wave superimposed on rate load(JEDEC method)	$I_{FSM}$			1	A
Storage temperature		$T_{STG}$	-40		+125	$^\circ\text{C}$
Junction temperature		$T_j$			+125	$^\circ\text{C}$

### Electrical Characteristics (at $T_A=25^\circ\text{C}$ unless otherwise noted)

Parameter	Conditions	Symbol	Min	Typ	Max	Unit
Forward voltage	$I_F = 10\text{ mA}$	$V_F$			0.45	V
Reverse current	$V_R = 10\text{ V}$	$I_R$			0.5	$\mu\text{A}$

## RATING AND CHARACTERISTIC CURVES (CDBU0130R-HF)

Fig. 1 - Forward characteristics

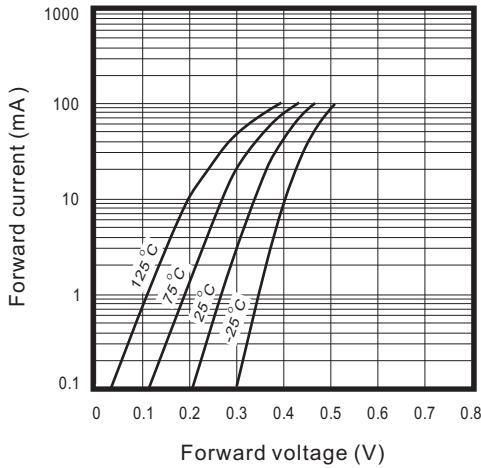

Fig. 2 - Reverse characteristics

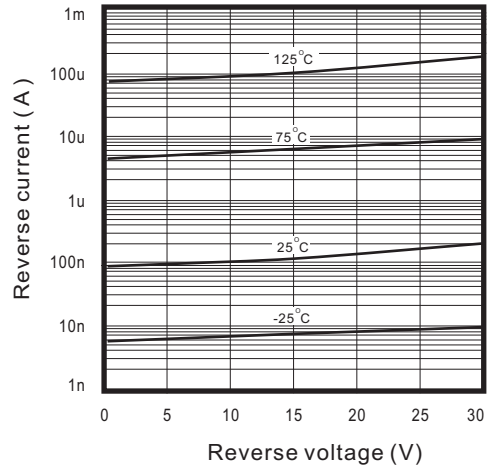

Fig. 3 - Capacitance between terminals characteristics

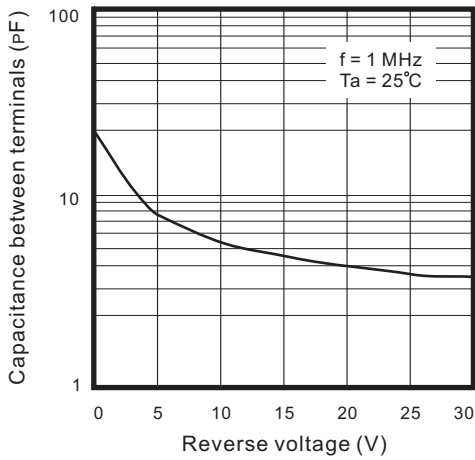

Fig. 4 - Current derating curve

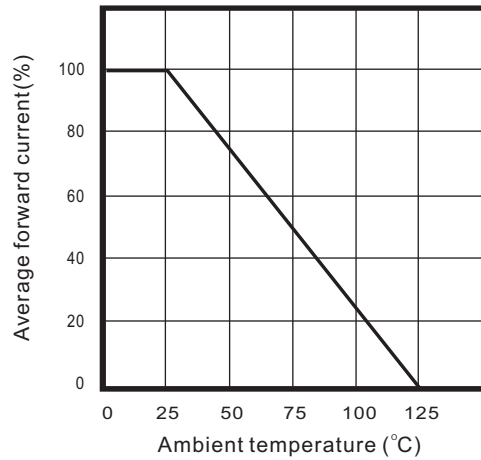

Fig. 5 - VF Dispersion map

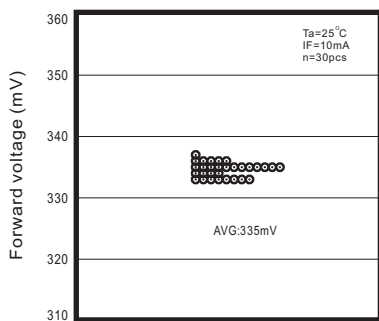

Fig. 6 - IR Dispersion map

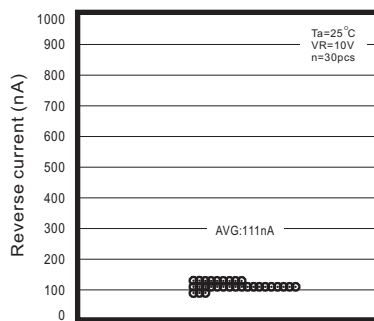
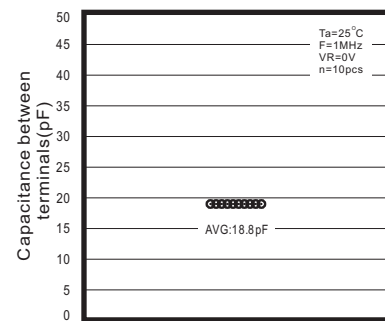
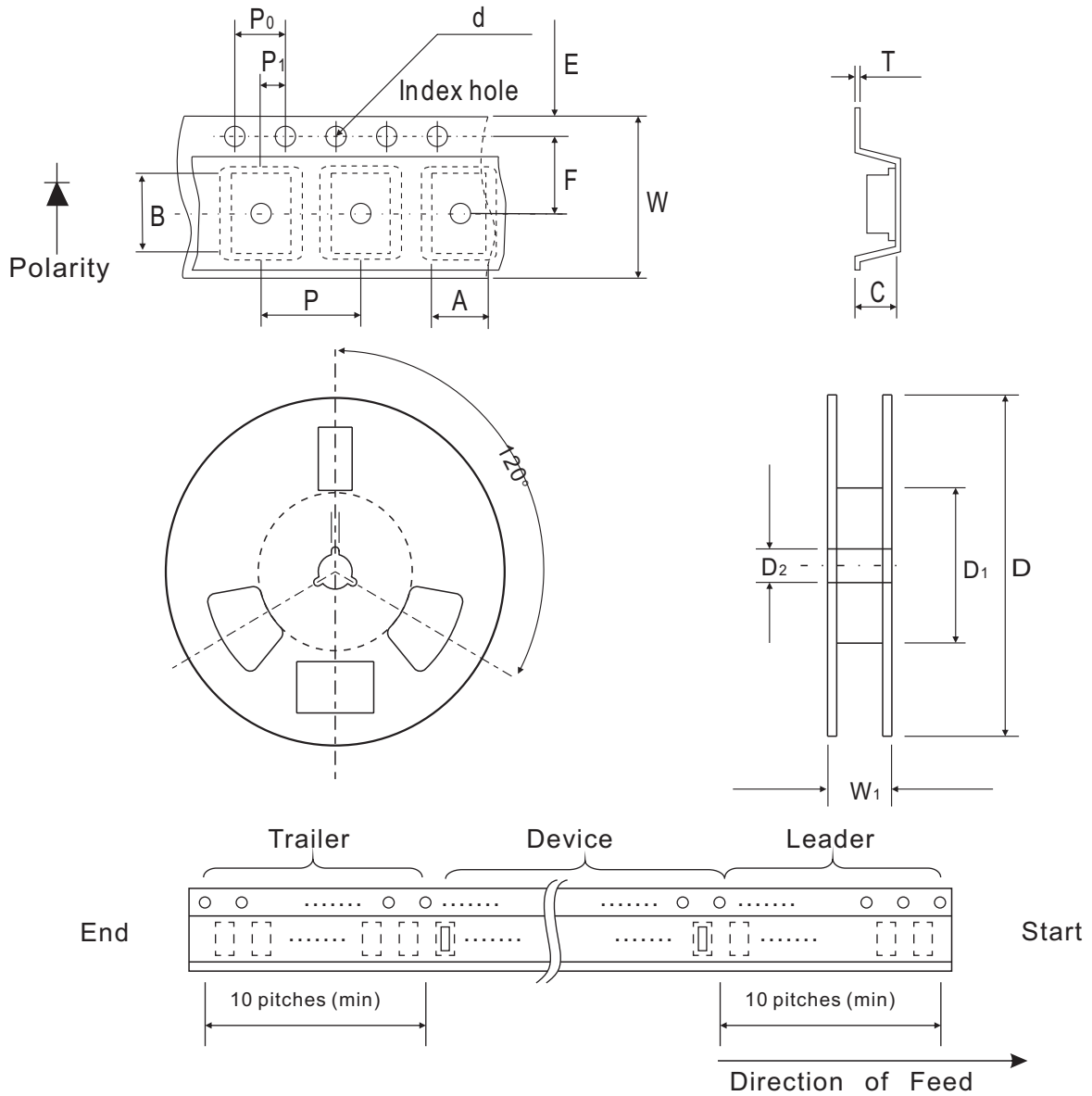

Fig. 7 - CT Dispersion map



## Reel Taping Specification



0603 (SOD-523F)	SYMBOL	A	B	C	d	D	D <sub>1</sub>	D <sub>2</sub>
	(mm)	1.00 ± 0.10	1.85 ± 0.10	1.00 ± 0.10	1.55 ± 0.05	178 ± 1	60.0 MIN.	13.0 ± 0.20
	(inch)	0.039 ± 0.004	0.073 ± 0.004	0.039 ± 0.004	0.061 ± 0.002	7.008 ± 0.04	2.362 MIN.	0.512 ± 0.008

0603 (SOD-523F)	SYMBOL	E	F	P	P <sub>0</sub>	P <sub>1</sub>	T	W	W <sub>1</sub>
	(mm)	1.75 ± 0.10	3.50 ± 0.05	4.00 ± 0.10	4.00 ± 0.10	2.00 ± 0.05	0.23 ± 0.05	8.00 ± 0.20	13.5 MAX.
	(inch)	0.069 ± 0.004	0.138 ± 0.002	0.157 ± 0.004	0.157 ± 0.004	0.079 ± 0.004	0.009 ± 0.002	0.315 ± 0.008	0.531 MAX.

## Marking Code

Part Number	Marking Code
CDBU0130R-HF	BQ



## Suggested PAD Layout

SIZE	0603/SOD-523F	
	(mm)	(inch)
A	1.70	0.067
B	0.60	0.024
C	0.80	0.031
D	2.30	0.091
E	1.10	0.043

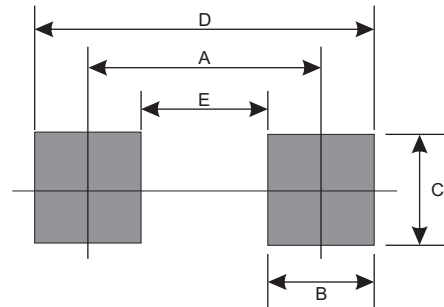

## Standard Package

Case Type	Qty per Reel	Reel Size
	(Pcs)	(inch)
0603/SOD-523F	4000	7

# AMEYA360

## Components Supply Platform

### Authorized Distribution Brand :



### Website :

Welcome to visit [www.ameya360.com](http://www.ameya360.com)

### Contact Us :

#### ➤ Address :

401 Building No.5, JiuGe Business Center, Lane 2301, Yishan Rd  
Minhang District, Shanghai , China

#### ➤ Sales :

Direct +86 (21) 6401-6692

Email [amall@ameya360.com](mailto:amall@ameya360.com)

QQ 800077892

Skype [ameyasales1](#) [ameyasales2](#)

#### ➤ Customer Service :

Email [service@ameya360.com](mailto:service@ameya360.com)

#### ➤ Partnership :

Tel +86 (21) 64016692-8333

Email [mkt@ameya360.com](mailto:mkt@ameya360.com)