



IR Emitter and Detector Product Data Sheet

LTE-2872U

Spec No.: DS-50-93-0018

Effective Date: 09/18/2010

Revision: B

LITE-ON DCC

RELEASE

BNS-OD-FC001/A4

FEATURES

- * SELECTED TO SPECIFIC ON-LINE INTENSITY AND RADIANT INTENSITY RANGES
- * LOW COST PLASTIC END LOOKING PACKAGE
- * MECHANICALLY AND SPECTRALLY MATCHED TO THE LTR-3208 SERIES OF PHOTOTRANSISTOR
- * THE LTE-2872U SERIES ARE MADE WITH GALLIUM ALUMINUM ARSENIDE WINDOW LAYER ON GALLIUM ARSENIDE INFRARED EMITTER DIODES
- * UL APPROVED FOR SMOKING DETECTOR, UL FILE NO.:S5010
- * NARROW BEAM
- * CLEAR TRANSPARENT COLOR PACKAGE

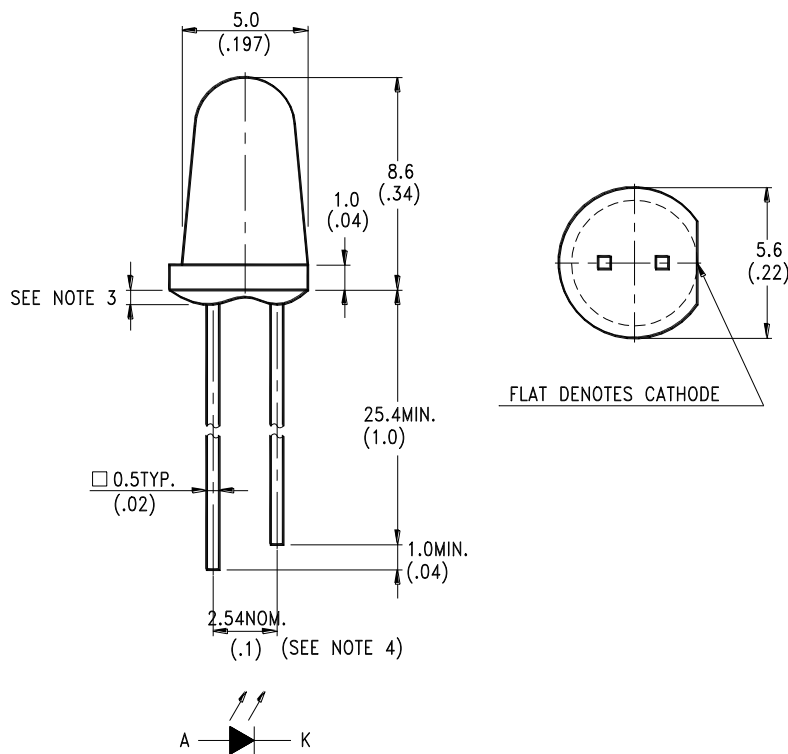
PACKAGE DIMENSIONS**NOTES:**

1. All dimensions are in millimeters (inches).
2. Tolerance is $\pm 0.25\text{mm}(.010\text{'})$ unless otherwise noted.
3. Protruded resin under flange is $1.5\text{mm}(.059\text{'})$ max.
4. Lead spacing is measured where the leads emerge from the package.
5. Specifications are subject to change without notice.



LITE-ON ELECTRONICS, INC.

Property of Lite-On Only

ABSOLUTE MAXIMUM RATINGS AT TA=25°C

PARAMETER	MAXIMUM RATING	UNIT
Power Dissipation	250	mW
Peak Forward Current (300pps, 10 μ s pulse)	3	A
Continuous Forward Current	150	mA
Reverse Voltage	5	V
Operating Temperature Range	-40°C to + 85°C	
Storage Temperature Range	-55°C to + 100°C	
Lead Soldering Temperature [1.6mm(.063") From Body]	260°C for 5 Seconds	

ELECTRICAL OPTICAL CHARACTERISTICS AT TA=25°C

PARAMETER	SYMBOL	MIN.	TYP.	MAX.	UNIT	TEST CONDITION	BIN NO.
Aperture Radiant Incidence	E _e	0.44		0.96	mW/cm ²	I _F = 20mA	BIN A
		0.64		1.20			BIN B
		0.80		1.68			BIN C
		1.12		1.90			BIN D1
		1.61		2.26			BIN D2
		1.92		2.69			BIN D3
		2.29					BIN D4
Radiant Intensity	I _E	3.31		7.22	mW/sr	I _F = 20mA	BIN A
		4.81		9.02			BIN B
		6.02		12.63			BIN C
		8.42		14.25			BIN D1
		12.07		16.95			BIN D2
		14.40		20.17			BIN D3
		17.17					BIN D4
Peak Emission Wavelength	λ_{Peak}		940		nm	I _F = 20mA	
Spectral Line Half-Width	$\Delta \lambda$		50		nm	I _F = 20mA	
Forward Voltage	V _F		1.2	1.6	V	I _F = 20mA	
Reverse Current	I _R			100	μ A	V _R = 5V	
Viewing Angle (See FIG.6)	2 $\theta_{1/2}$		16		deg.		

TYPICAL ELECTRICAL / OPTICAL CHARACTERISTICS CURVES

(25°C Ambient Temperature Unless Otherwise Noted)

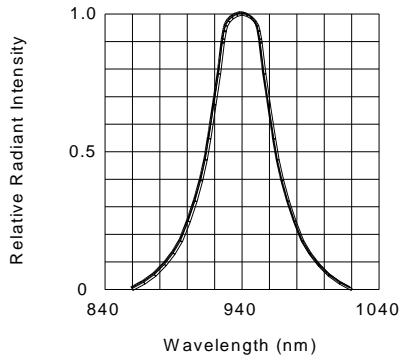

FIG.1 SPECTRAL DISTRIBUTION

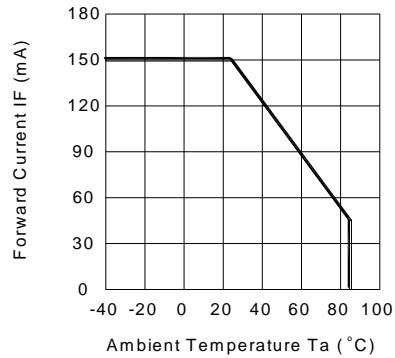

FIG.2 FORWARD CURRENT VS. AMBIENT TEMPERATURE

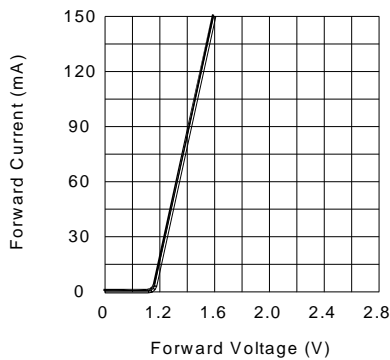

FIG.3 FORWARD CURRENT VS. FORWARD VOLTAGE

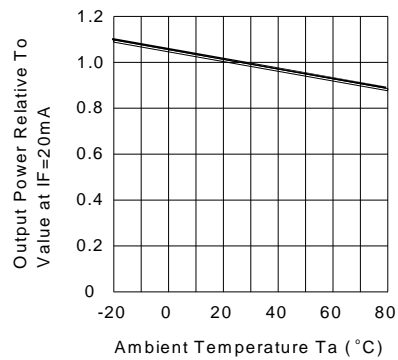

FIG.4 RELATIVE RADIANT INTENSITY VS. AMBIENT TEMPERATURE

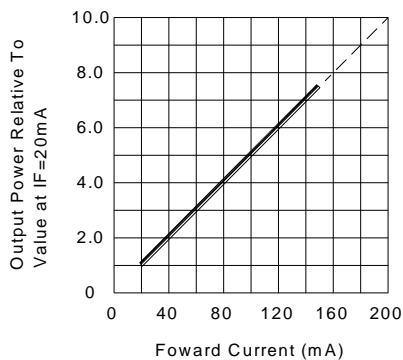

FIG.5 RELATIVE RADIANT INTENSITY VS. FORWARD CURRENT

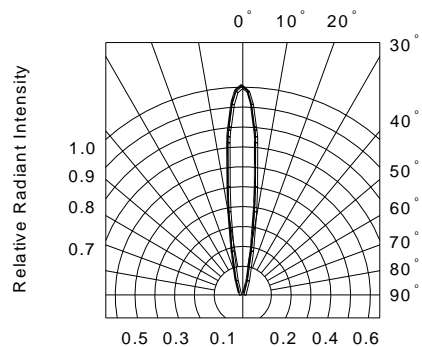

FIG.6 RADIATION DIAGRAM

AMEYA360

Components Supply Platform

Authorized Distribution Brand :



Website :

Welcome to visit www.ameya360.com

Contact Us :

➤ Address :

401 Building No.5, JiuGe Business Center, Lane 2301, Yishan Rd
Minhang District, Shanghai , China

➤ Sales :

Direct +86 (21) 6401-6692

Email amall@ameya360.com

QQ 800077892

Skype [ameyasales1](#) [ameyasales2](#)

➤ Customer Service :

Email service@ameya360.com

➤ Partnership :

Tel +86 (21) 64016692-8333

Email mkt@ameya360.com