

# NVR5198NL

## Power MOSFET

60 V, 155 mΩ, Single N-Channel Logic Level, SOT-23

### Features

- Small Footprint Industry Standard Surface Mount SOT-23 Package
- Low  $R_{DS(on)}$  for Low Conduction Losses and Improved Efficiency
- AEC-Q101 Qualified and PPAP Capable
- These Devices are Pb-Free, Halogen Free/BFR Free and are RoHS Compliant

### MAXIMUM RATINGS ( $T_J = 25^\circ\text{C}$ unless otherwise noted)

Parameter	Symbol	Value	Unit	
Drain-to-Source Voltage	$V_{DSS}$	60	V	
Gate-to-Source Voltage	$V_{GS}$	$\pm 20$	V	
Continuous Drain Current $R_{\Psi J-mb}$ (Notes 1, 2, 3, and 4)	Steady State	$T_A = 25^\circ\text{C}$	$I_D$ 2.2	A
		$T_A = 100^\circ\text{C}$	1.6	
Power Dissipation $R_{\Psi J-mb}$ (Notes 1 and 3)	Steady State	$T_A = 25^\circ\text{C}$	$P_D$ 1.5	W
		$T_A = 100^\circ\text{C}$	0.6	
Continuous Drain Current $R_{\theta JA}$ (Note 1, 2, 3, and 4)	Steady State	$T_A = 25^\circ\text{C}$	$I_D$ 1.7	A
		$T_A = 100^\circ\text{C}$	1.2	
Power Dissipation $R_{\theta JA}$ (Notes 1 and 3)	Steady State	$T_A = 25^\circ\text{C}$	$P_D$ 0.9	W
		$T_A = 100^\circ\text{C}$	0.4	
Pulsed Drain Current	$T_A = 25^\circ\text{C}$ , $t_p = 10 \mu\text{s}$	$I_{DM}$ 27	A	
Operating Junction and Storage Temperature	$T_J$ , $T_{stg}$	-55 to 150	$^\circ\text{C}$	
Source Current (Body Diode)	$I_S$	1.9	A	
Lead Temperature for Soldering Purposes (1/8" from case for 10 s)	$T_L$	260	$^\circ\text{C}$	

Stresses exceeding Maximum Ratings may damage the device. Maximum Ratings are stress ratings only. Functional operation above the Recommended Operating Conditions is not implied. Extended exposure to stresses above the Recommended Operating Conditions may affect device reliability.

1. The entire application environment impacts the thermal resistance values shown, they are not constants and are only valid for the particular conditions noted.
2. Psi ( $\Psi$ ) is used as required per JESD51-12 for packages in which substantially less than 100% of the heat flows to single case surface.
3. Surface-mounted on FR4 board using a 650 mm<sup>2</sup>, 2 oz. Cu pad.
4. Maximum current for pulses as long as 1 second is higher but is dependent on pulse duration and duty cycle.



ON Semiconductor®

<http://onsemi.com>

$V_{(BR)DSS}$	$R_{DS(on)}$ TYP	$I_D$ MAX
60 V	155 mΩ @ 10 V	2.2 A
	205 mΩ @ 4.5 V	

### N-Channel

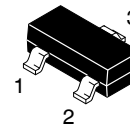
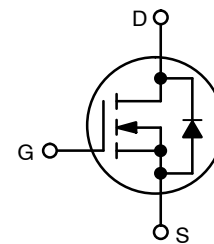

SOT-23  
CASE 318  
STYLE 21

### MARKING DIAGRAM/ PIN ASSIGNMENT

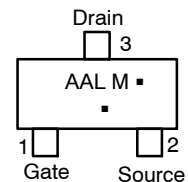

AAL = Device Code  
M = Date Code\*  
▪ = Pb-Free Package

(Note: Microdot may be in either location)

\*Date Code orientation may vary depending upon manufacturing location.

### ORDERING INFORMATION

Device	Package	Shipping†
NVR5198NLT1G	SOT-23 (Pb-Free)	3000 / Tape & Reel
NVR5198NLT3G	SOT-23 (Pb-Free)	10000 / Tape & Reel

†For information on tape and reel specifications, including part orientation and tape sizes, please refer to our Tape and Reel Packaging Specification Brochure, BRD8011/D.

# NVR5198NL

## THERMAL RESISTANCE RATINGS

Parameter	Symbol	Max	Unit
Junction-to-Lead #3 – Drain (Notes 2 and 3)	$R_{\psi J-mb}$	86	°C/W
Junction-to-Ambient – Steady State (Note 3)	$R_{\theta JA}$	139	°C/W

## ELECTRICAL CHARACTERISTICS ( $T_J = 25^\circ\text{C}$ unless otherwise noted)

Parameter	Symbol	Test Conditions	Min	Typ	Max	Unit
<b>OFF CHARACTERISTICS</b>						
Drain-to-Source Breakdown Voltage	$V_{(BR)DSS}$	$V_{GS} = 0\text{ V}, I_D = 250\ \mu\text{A}$	60			V
Drain-to-Source Breakdown Voltage Temperature Coefficient	$V_{(BR)DSS}/T_J$	Reference to $25^\circ\text{C}$ , $I_D = 250\ \mu\text{A}$		70		$\text{mV}/^\circ\text{C}$
Zero Gate Voltage Drain Current	$I_{DSS}$	$V_{GS} = 0\text{ V}, V_{DS} = 60\text{ V}$	$T_J = 25^\circ\text{C}$		1.0	$\mu\text{A}$
			$T_J = 125^\circ\text{C}$		10	
Gate-to-Source Leakage Current	$I_{GSS}$	$V_{DS} = 0\text{ V}, V_{GS} = \pm 20\text{ V}$			$\pm 100$	nA

## ON CHARACTERISTICS (Note 5)

Gate Threshold Voltage	$V_{GS(TH)}$	$V_{GS} = V_{DS}, I_D = 250\ \mu\text{A}$	1.5		2.5	V
Threshold Temperature Coefficient	$V_{GS(TH)}/T_J$	Reference to $25^\circ\text{C}$ , $I_D = 250\ \mu\text{A}$		-6.5		$\text{mV}/^\circ\text{C}$
Drain-to-Source On-Resistance	$R_{DS(on)}$	$V_{GS} = 10\text{ V}, I_D = 1\text{ A}$		107	155	$\text{m}\Omega$
		$V_{GS} = 4.5\text{ V}, I_D = 1\text{ A}$		142	205	
Forward Transconductance	$g_{FS}$	$V_{DS} = 5.0\text{ V}, I_D = 1\text{ A}$		3		S

## CHARGES, CAPACITANCES & GATE RESISTANCE

Input Capacitance	$C_{iss}$	$V_{GS} = 0\text{ V}, f = 1.0\text{ MHz}, V_{DS} = 25\text{ V}$		182		$\text{pF}$
Output Capacitance	$C_{oss}$			25		
Reverse Transfer Capacitance	$C_{rss}$			16		
Total Gate Charge	$Q_G(TOT)$	$V_{DS} = 48\text{ V}, I_D = 1\text{ A}$	$V_{GS} = 4.5\text{ V}$		2.8	$\text{nC}$
			$V_{GS} = 10\text{ V}$		5.1	
Threshold Gate Charge	$Q_G(TH)$	$V_{DS} = 48\text{ V}, I_D = 1\text{ A}, V_{GS} = 10\text{ V}$			0.3	
Gate-to-Source Charge	$Q_{GS}$				0.8	
Gate-to-Drain Charge	$Q_{GD}$				1.5	
Plateau Voltage	$V_{GP}$				3.1	V
Gate Resistance	$R_G$				8	$\Omega$

## SWITCHING CHARACTERISTICS (Note 6)

Turn-On Delay Time	$t_{d(on)}$	$V_{DS} = 30\text{ V}, V_{GS} = 10\text{ V}, I_D = 1\text{ A}, R_G = 10\ \Omega$		5		ns
Rise Time	$t_r$			7		
Turn-Off Delay Time	$t_{d(off)}$			13		
Fall Time	$t_f$			2		

## DRAIN-SOURCE DIODE CHARACTERISTICS

Forward Diode Voltage	$V_{SD}$	$V_{GS} = 0\text{ V}, I_S = 1\text{ A}$	$T_J = 25^\circ\text{C}$		0.8	1.2	V
			$T_J = 125^\circ\text{C}$		0.6		
Reverse Recovery Time	$t_{rr}$	$I_S = 1\text{ A}_{dc}, V_{GS} = 0\text{ V}_{dc}, di_S/dt = 100\text{ A}/\mu\text{s}$			12		ns
Charge Time	$t_a$				9		
Discharge Time	$t_b$				3		
Reverse Recovery Stored Charge	$Q_{RR}$				6		

5. Pulse Test: Pulse Width  $\leq 300\ \mu\text{s}$ , Duty Cycle  $\leq 2\%$ .

6. Switching characteristics are independent of operating junction temperatures.

TYPICAL CHARACTERISTICS

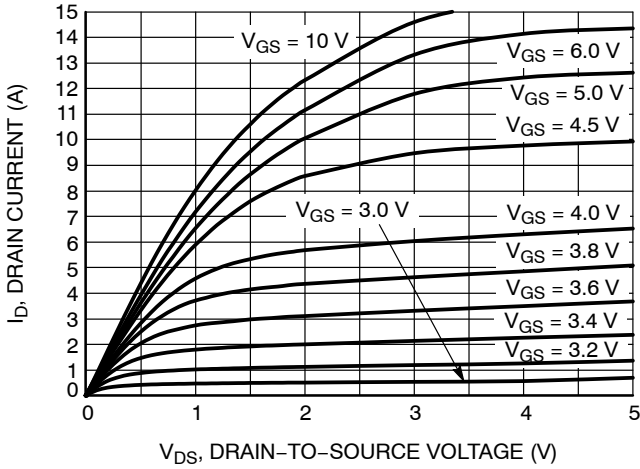

Figure 1. On-Region Characteristics

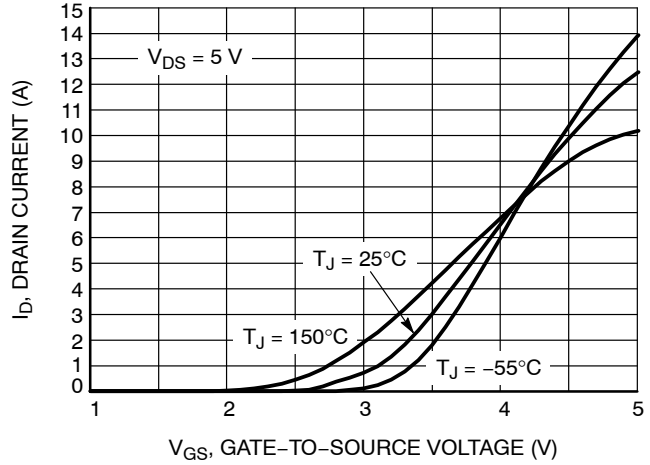

Figure 2. Transfer Characteristics

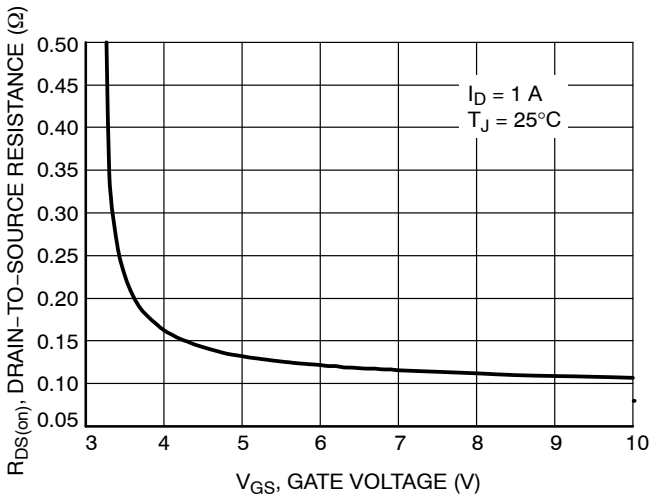

Figure 3. On-Resistance vs. Gate-to-Source Voltage

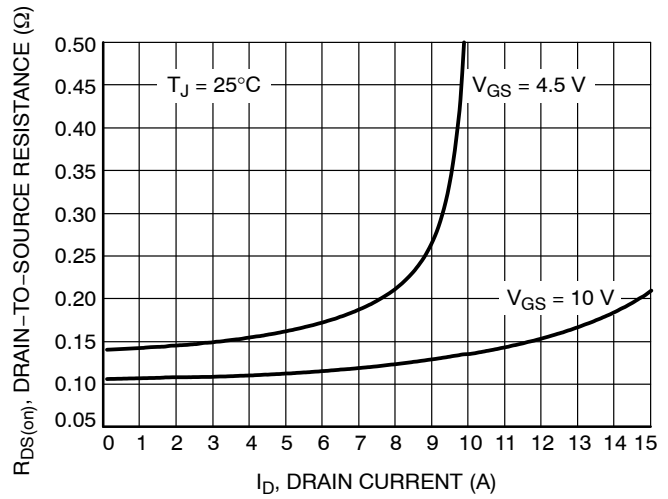

Figure 4. On-Resistance vs. Drain Current and Gate Voltage

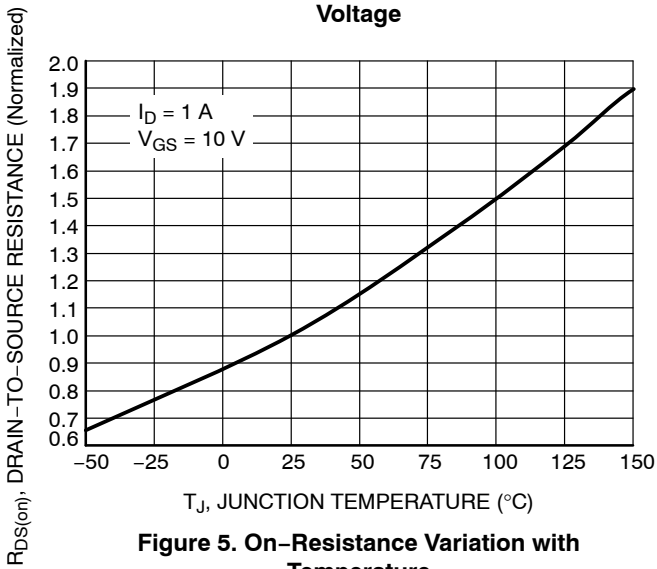

Figure 5. On-Resistance Variation with Temperature

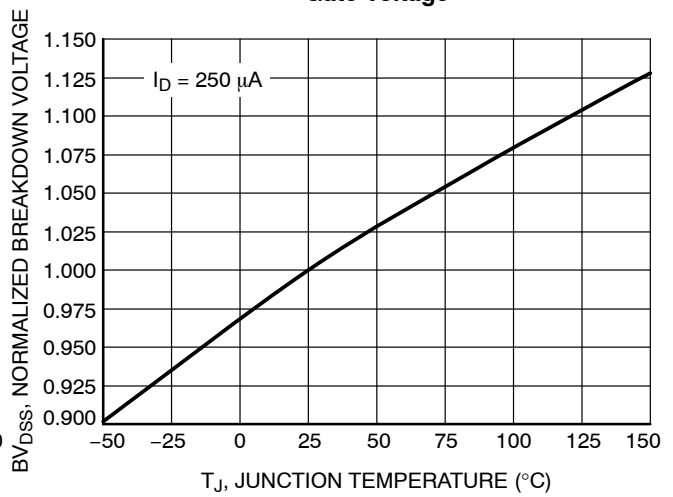

Figure 6. Breakdown Voltage Variation with Temperature

TYPICAL CHARACTERISTICS

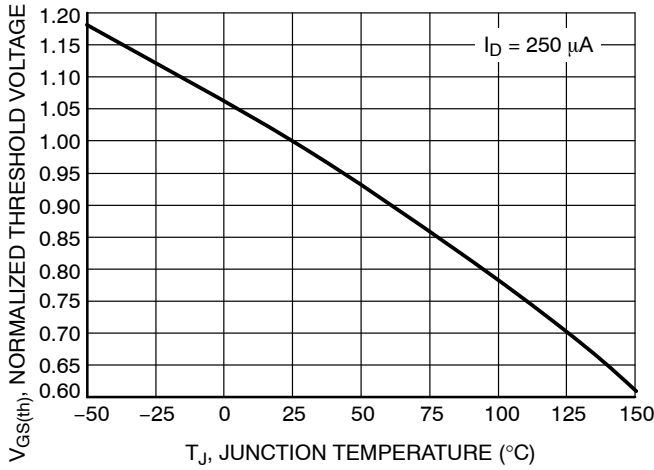

Figure 7. Threshold Voltage Variation with Temperature

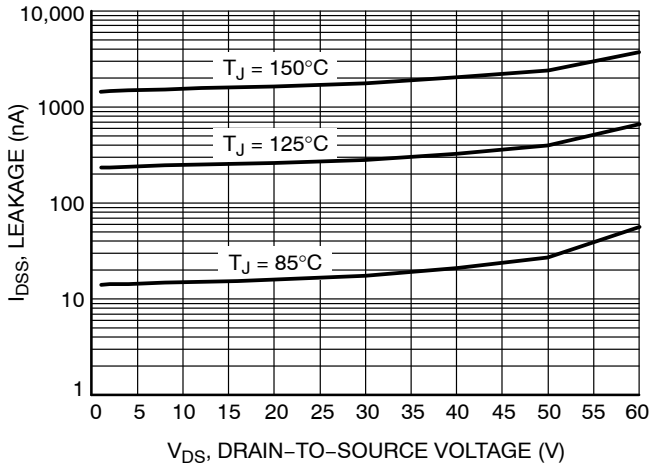

Figure 8. Drain-to-Source Leakage Current vs. Voltage

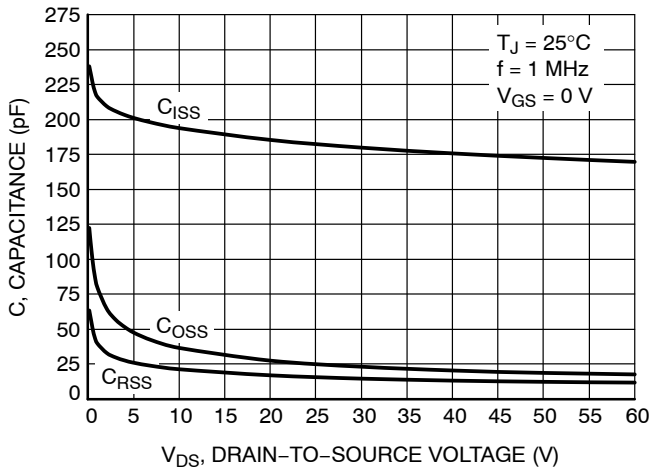

Figure 9. Capacitance Variation

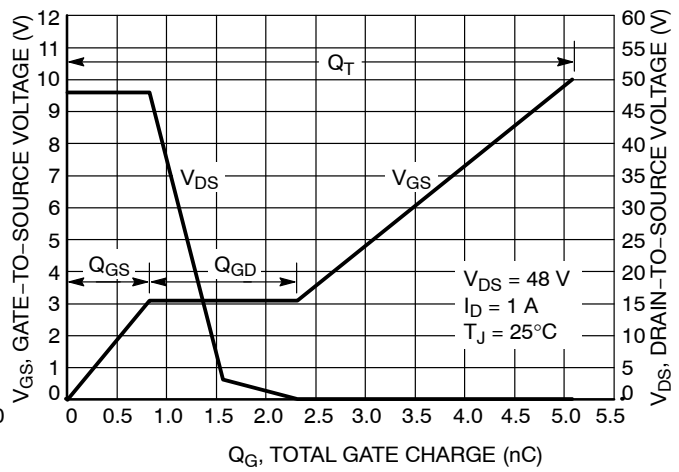

Figure 10. Gate-to-Source and Drain-to-Source Voltage vs. Total Charge

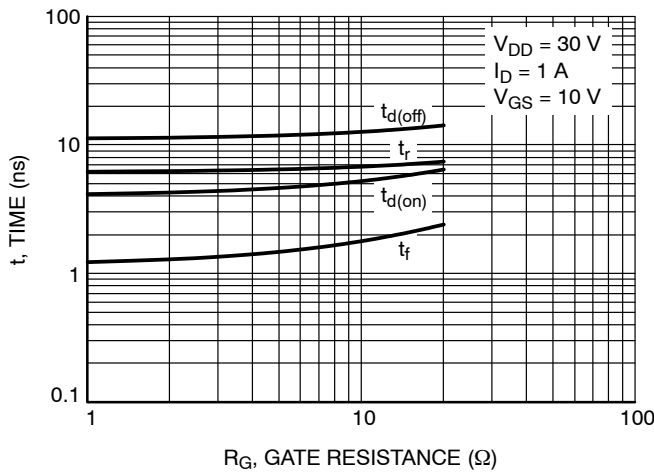

Figure 11. Resistive Switching Time Variation vs. Gate Resistance

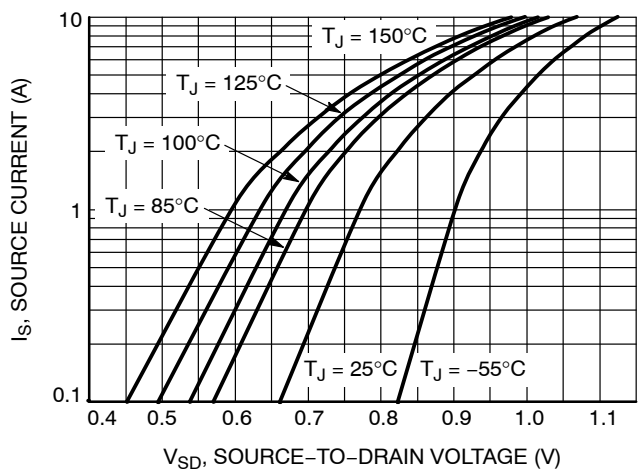
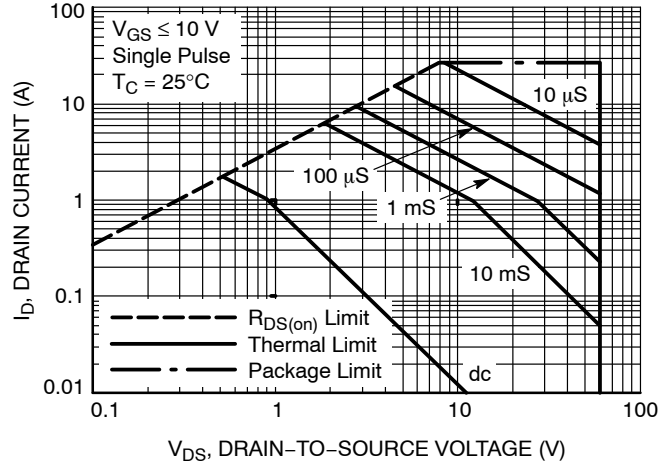

Figure 12. Diode Forward Voltage vs. Current

# NVR5198NL

## TYPICAL CHARACTERISTICS



**Figure 13. Maximum Rated Forward Biased Safe Operating Area**

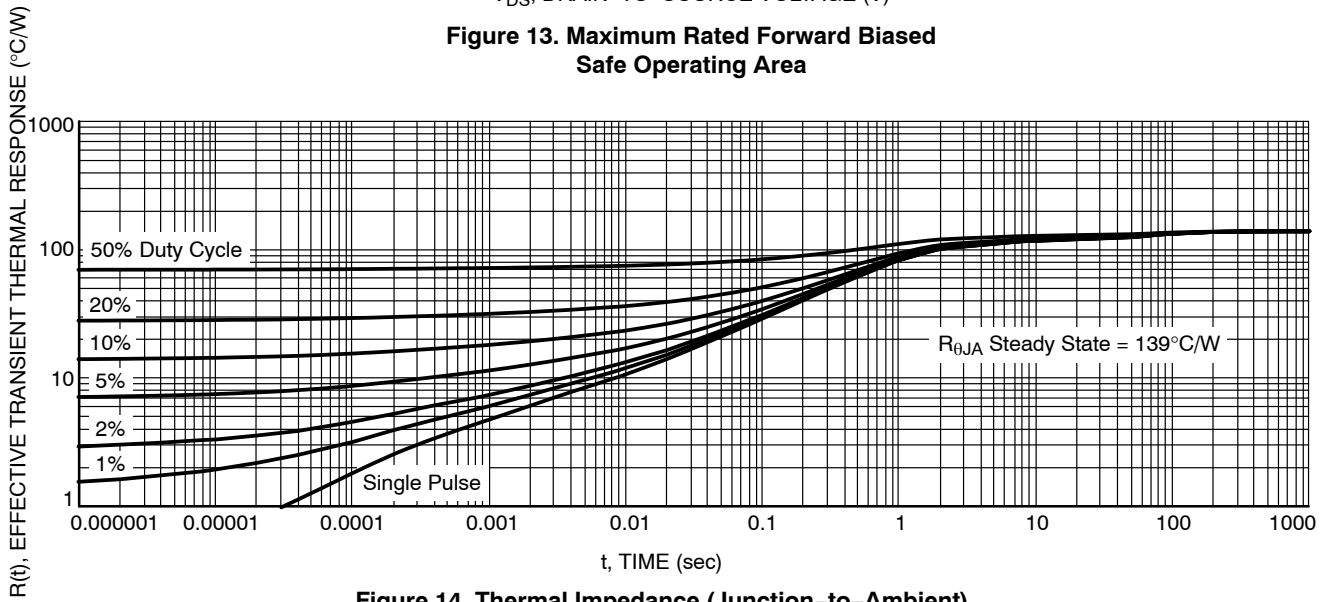
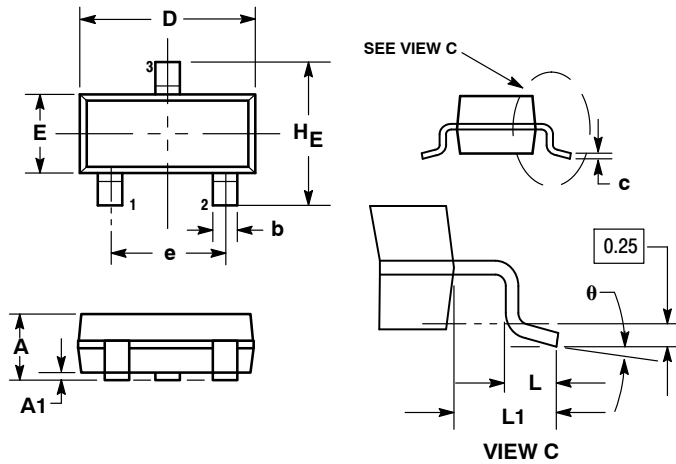

**Figure 14. Thermal Impedance (Junction-to-Ambient)**

# NVR5198NL

## PACKAGE DIMENSIONS

SOT-23 (TO-236)  
CASE 318-08  
ISSUE AP



- NOTES:
1. DIMENSIONING AND TOLERANCING PER ANSI Y14.5M, 1982.
  2. CONTROLLING DIMENSION: INCH.
  3. MAXIMUM LEAD THICKNESS INCLUDES LEAD FINISH THICKNESS. MINIMUM LEAD THICKNESS IS THE MINIMUM THICKNESS OF BASE MATERIAL.
  4. DIMENSIONS D AND E DO NOT INCLUDE MOLD FLASH, PROTRUSIONS, OR GATE BURRS.

DIM	MILLIMETERS			INCHES		
	MIN	NOM	MAX	MIN	NOM	MAX
A	0.89	1.00	1.11	0.035	0.040	0.044
A1	0.01	0.06	0.10	0.001	0.002	0.004
b	0.37	0.44	0.50	0.015	0.018	0.020
c	0.09	0.13	0.18	0.003	0.005	0.007
D	2.80	2.90	3.04	0.110	0.114	0.120
E	1.20	1.30	1.40	0.047	0.051	0.055
e	1.78	1.90	2.04	0.070	0.075	0.081
L	0.10	0.20	0.30	0.004	0.008	0.012
L1	0.35	0.54	0.69	0.014	0.021	0.029
HE	2.10	2.40	2.64	0.083	0.094	0.104
θ	0°	---	10°	0°	---	10°

STYLE 21:  
PIN 1. GATE  
2. SOURCE  
3. DRAIN

### SOLDERING FOOTPRINT\*

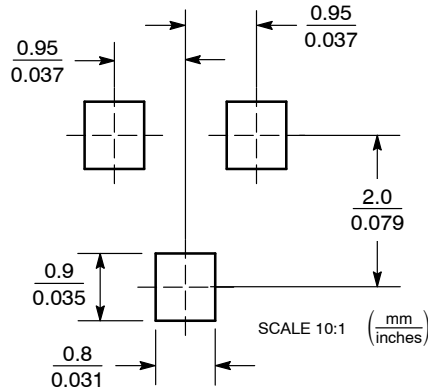

\*For additional information on our Pb-Free strategy and soldering details, please download the ON Semiconductor Soldering and Mounting Techniques Reference Manual, SOLDERRM/D.

ON Semiconductor and are registered trademarks of Semiconductor Components Industries, LLC (SCILLC). SCILLC owns the rights to a number of patents, trademarks, copyrights, trade secrets, and other intellectual property. A listing of SCILLC's product/patent coverage may be accessed at [www.onsemi.com/site/pdf/Patent-Marking.pdf](http://www.onsemi.com/site/pdf/Patent-Marking.pdf). SCILLC reserves the right to make changes without further notice to any products herein. SCILLC makes no warranty, representation or guarantee regarding the suitability of its products for any particular purpose, nor does SCILLC assume any liability arising out of the application or use of any product or circuit, and specifically disclaims any and all liability, including without limitation special, consequential or incidental damages. "Typical" parameters which may be provided in SCILLC data sheets and/or specifications can and do vary in different applications and actual performance may vary over time. All operating parameters, including "Typicals" must be validated for each customer application by customer's technical experts. SCILLC does not convey any license under its patent rights nor the rights of others. SCILLC products are not designed, intended, or authorized for use as components in systems intended for surgical implant into the body, or other applications intended to support or sustain life, or for any other application in which the failure of the SCILLC product could create a situation where personal injury or death may occur. Should Buyer purchase or use SCILLC products for any such unintended or unauthorized application, Buyer shall indemnify and hold SCILLC and its officers, employees, subsidiaries, affiliates, and distributors harmless against all claims, costs, damages, and expenses, and reasonable attorney fees arising out of, directly or indirectly, any claim of personal injury or death associated with such unintended or unauthorized use, even if such claim alleges that SCILLC was negligent regarding the design or manufacture of the part. SCILLC is an Equal Opportunity/Affirmative Action Employer. This literature is subject to all applicable copyright laws and is not for resale in any manner.

### PUBLICATION ORDERING INFORMATION

**LITERATURE FULFILLMENT:**  
Literature Distribution Center for ON Semiconductor  
P.O. Box 5163, Denver, Colorado 80217 USA  
**Phone:** 303-675-2175 or 800-344-3860 Toll Free USA/Canada  
**Fax:** 303-675-2176 or 800-344-3867 Toll Free USA/Canada  
**Email:** [orderlit@onsemi.com](mailto:orderlit@onsemi.com)

**N. American Technical Support:** 800-282-9855 Toll Free  
USA/Canada  
**Europe, Middle East and Africa Technical Support:**  
Phone: 421 33 790 2910  
**Japan Customer Focus Center**  
Phone: 81-3-5817-1050

**ON Semiconductor Website:** [www.onsemi.com](http://www.onsemi.com)  
**Order Literature:** <http://www.onsemi.com/orderlit>  
For additional information, please contact your local Sales Representative

# AMEYA360

## Components Supply Platform

Authorized Distribution Brand :



Website :

Welcome to visit [www.ameya360.com](http://www.ameya360.com)

Contact Us :

➤ Address :

401 Building No.5, JiuGe Business Center, Lane 2301, Yishan Rd  
Minhang District, Shanghai , China

➤ Sales :

Direct +86 (21) 6401-6692

Email [amall@ameya360.com](mailto:amall@ameya360.com)

QQ 800077892

Skype [ameyasales1](#) [ameyasales2](#)

➤ Customer Service :

Email [service@ameya360.com](mailto:service@ameya360.com)

➤ Partnership :

Tel +86 (21) 64016692-8333

Email [mkt@ameya360.com](mailto:mkt@ameya360.com)