

Features

- Wide input voltage range from 2.5V to 5.5V
- 200mV low dropout voltage at 150mA output current
- Guaranteed 150mA output current.
- Low quiescent current 50 μ A
- Output voltage from 1.0V to 3.5V
- $\pm 2\%$ output voltage accuracy
- Low temperature drift at output voltage
- High PSRR
- Fast transient response
- Current limit protection
- Short circuit protection
- Thermal shutdown protection
- SOT25 and SOT353: Available in "Green" Molding Compound (No Br, Sb)
- Lead Free Finish/RoHS Compliant (Note 1)

General Description

The AP7115 is a 150mA, fixed output voltage, low dropout linear regulator. The device includes pass element, error amplifier, band gap reference, current-limit and thermal shutdown circuit. The characteristics of low dropout voltage and low quiescent current make it suitable for use in battery powered devices. The typical quiescent current is approximately 50 μ A. Several fixed output voltages are available from 1.0V to 3.5V. Additional protection is provided with built-in current-limit and thermal-shutdown functions.

Applications

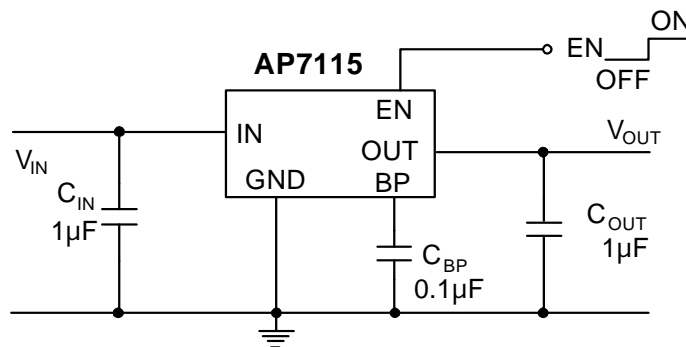

- Wireless Communication
- GSM/GPRS Cellular Phones
- Handheld Mobile Devices
- Battery Powered Devices
- CD-ROM, DVD, and LAN Cards
- PC and Notebook Peripherals

Typical Application Circuit

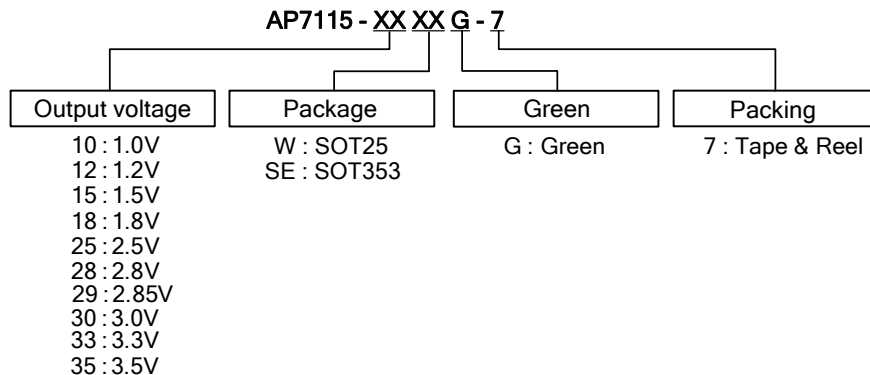

Ordering Information



Device	Package Code	Packaging (Note 2)	7" Tape and Reel	
			Quantity	Part Number Suffix
 AP7115-XXWG-7	W	SOT25	3000/Tape & Reel	-7
 AP7115-XXSEG-7	SE	SOT353	3000/Tape & Reel	-7

Notes: 1. EU Directive 2002/95/EC (RoHS). All applicable RoHS exemptions applied. Please visit our website at http://www.diodes.com/products/lead_free.html.
 2. Pad layout as shown on Diodes Inc. suggested pad layout document AP02001, which can be found on our website at <http://www.diodes.com/datasheets/ap02001.pdf>.

Pin Assignments

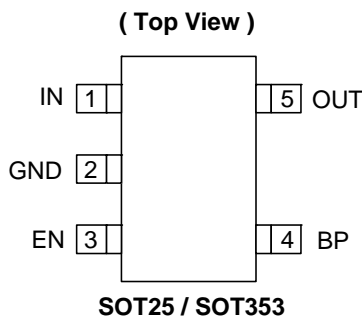

Pin Descriptions

Pin Name	Pin NO.	Description
IN	1	Voltage Input
GND	2	Ground
EN	3	Chip Enable Control
BP	4	Band-Gap Bypass
OUT	5	Voltage Output

Block Diagram

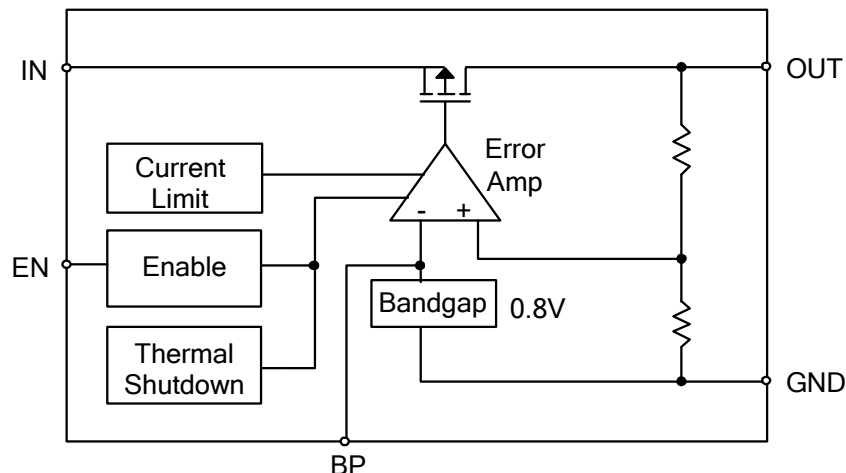

Absolute Maximum Ratings

Symbol	Parameter	Rating	Unit
ESD HBM	Human Body Model ESD Protection	3.5	KV
ESD MM	Machine Model ESD Protection	400	V
V_{IN}	Input Voltage	-0.3~5.5	V
V_{CE}	CE Pin Voltage	-0.3~5.5	V
V_{OUT}	Output Voltage	-0.3~ $V_{in}+0.3$	V
V_{BP}	Band Gap Bypass Pin Voltage	-0.3~5.5	V
P_D	Power Dissipation	500	mW
T_J	Operating Junction Temperature Range	-40 to +125	°C
T_{ST}	Storage Temperature Range	-65 to +150	°C

Recommended Operating Conditions

Symbol	Parameter	Min	Max	Unit
V_{IN}	Input Voltage	2.5	5.5	V
I_{OUT}	Output Current	-	150	mA
T_A	Operating Ambient Temperature	-40	85	°C

Electrical Characteristics ($V_{CC} = 3.3V$, $I_L = 30mA$, $C_{IN} = 1\mu F$, $C_{OUT} = 1\mu F$, $T_A = 25^\circ C$)

Symbol	Parameter	Conditions	Min	Typ.	Max	Unit
System Supply Input						
V_{IN}	Operating input voltage	$I_L = 0 \sim 150mA$	2.5		5.5	V
$\Delta V_{OUT}/V_{OUT}$	Output Voltage Accuracy	$V_{IN} = V_{OUT} + 1V$ where $1mA \leq I_{OUT} \leq 50mA$	-2		2	%
V_{DO}	Dropout Voltage	$I_L = 150mA$		200	300	mV
I_{OUT}	Output Current	$V_{IN} - V_{OUT} = 1V$	150			mA
I_Q	Quiescent Current	$V_{IN} = V_{OUT} + 1V$ where $I_{OUT} = 0$ and $V_{CE} = V_{IN}$		50	80	μA
$I_{shutdown}$	Shutdown Current	$V_{IN} = V_{OUT} + 1V$ where $I_{OUT} = 0$ and $V_{CE} = 0$		0.1	1	μA
PSRR	Power Supply Rejection Ratio	$I_{OUT} = 30mA$, $f = 1kHz$		70		dB
I_{limit}	Current Limit		200	250		mA
Thermal Management						
$T_{shutdown}$	Thermal Shutdown			150		$^\circ C$
Reference Voltage						
$\Delta V_{REF}/\Delta T$	Tempco of Bandgap Reference			30	50	ppm/ $^\circ C$
$\Delta V_{OUT}/\Delta T$	Tempco of Output Voltage	$I_{OUT} = 30mA$, $-40^\circ C \leq T \leq 85^\circ C$		50	100	ppm/ $^\circ C$
Control and Protection						
$V_{IH,CE}$			2.0			V
$V_{IL,CE}$					0.7	V
I_{CE}	CE Pin Leakage Current	$V_{CE} = V_{IN}$ @ $V_{IN} = 5.0V$ and $V_{SS} = 0V$ $V_{CE} = V_{SS}$ @ $V_{IN} = 5.0V$ and $V_{SS} = 0V$		0.01	0.1	μA
Regulation						
$\Delta V_O/\Delta V_{IN}$	Line Regulation	$V_{OUT} + 0.5V \leq V_{IN} \leq 5.5V$ where $V_{OUT} > 2.0V$, $I_{OUT} = 30mA$		0.02	0.1	%/V
ΔV_{LOAD}	Load Regulation	$1mA \leq I_L \leq 150mA$ where $V_{IN} = V_{OUT} + 1V$		0.003	0.006	%/mA
Noise						
e_n	Output Noise	$BW = 10Hz \sim 100kHz$		50		μV_{rms}
Thermal Resistance						
θ_{JA}	Thermal Resistance Junction-to-Ambient	SOT25 (Note 3)	-	200	-	$^\circ C/W$
		SOT353 (Note 3)		337		$^\circ C/W$
θ_{JC}	Thermal Resistance Junction-to-Case	SOT25 (Note 3)	-	52	-	$^\circ C/W$
		SOT353 (Note 3)		121		$^\circ C/W$

Notes: 3. Test condition for SOT25 and SOT353: Device mounted on FR-4 substrate PC board, 2oz copper, with minimum recommended pad layout.

Typical Operating Characteristics

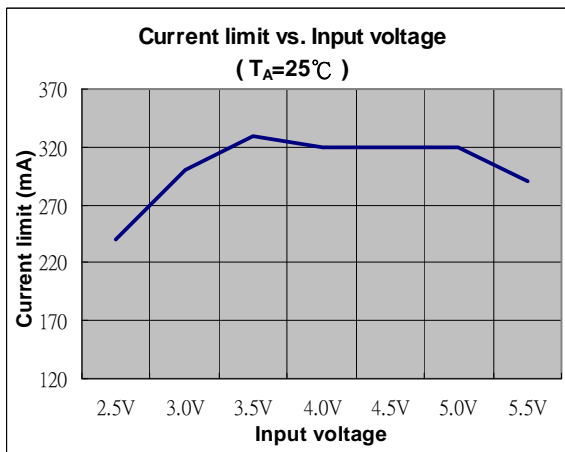
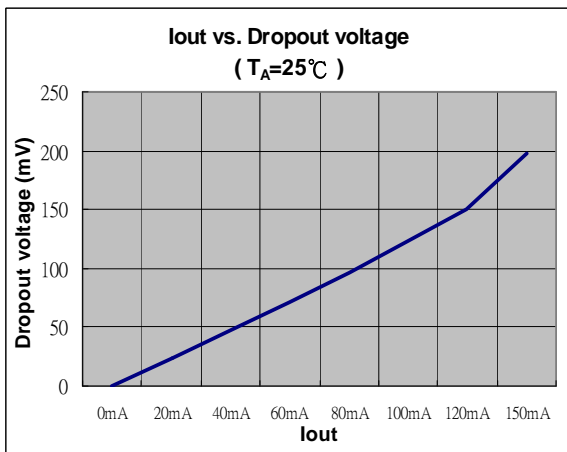
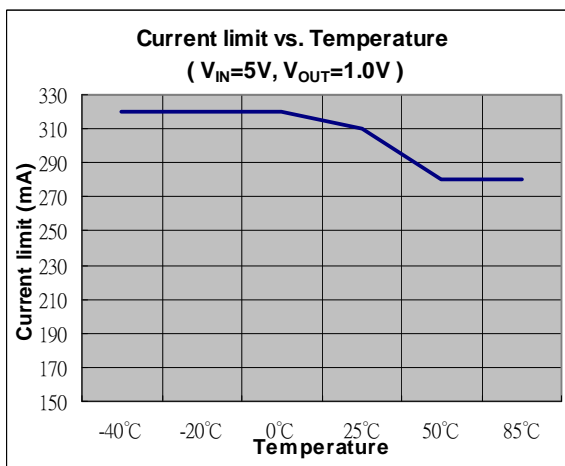
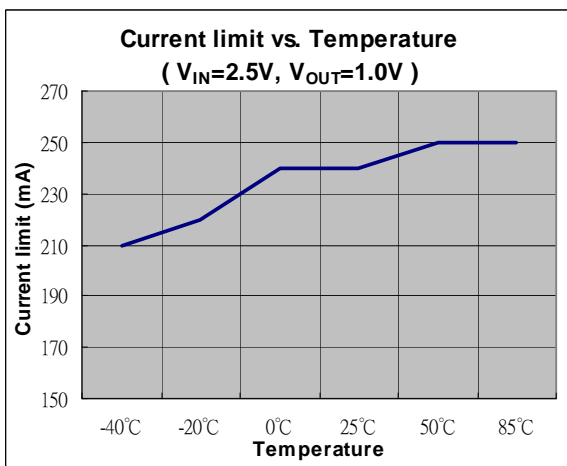
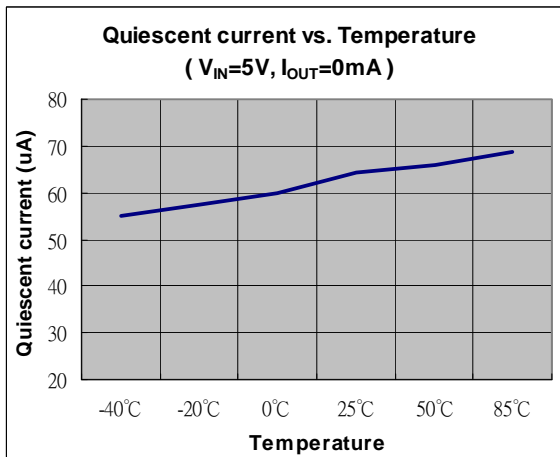
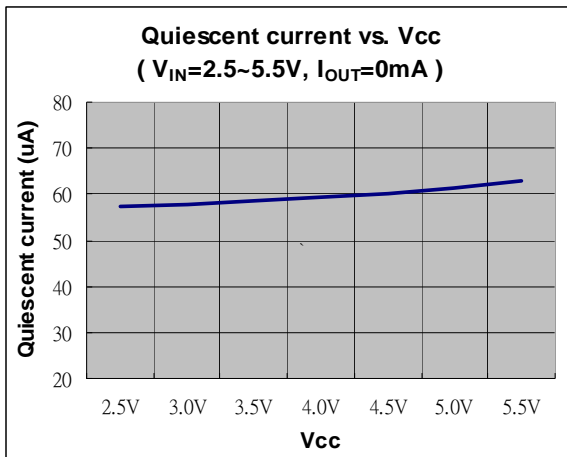

Typical Operating Characteristics (Continued)

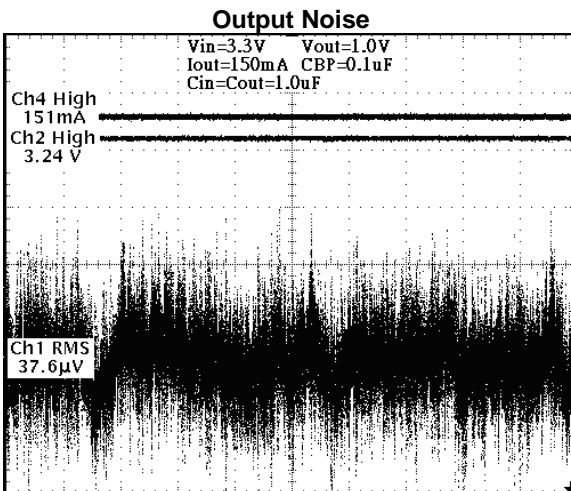
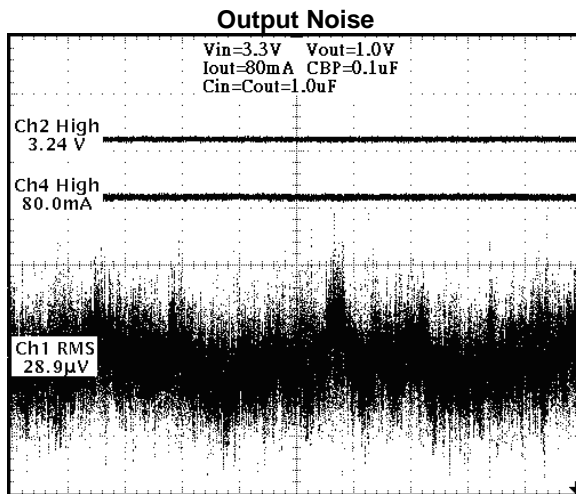
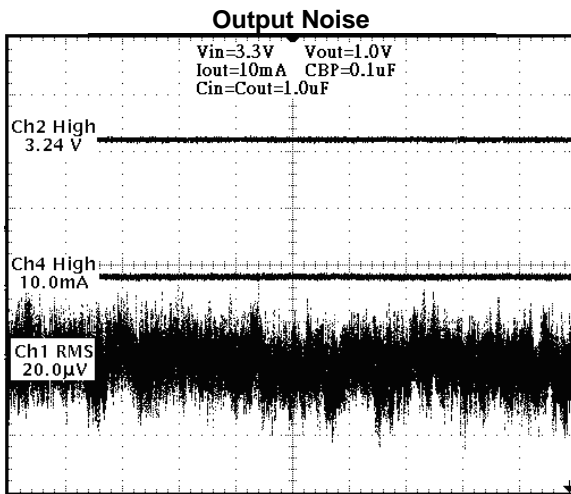
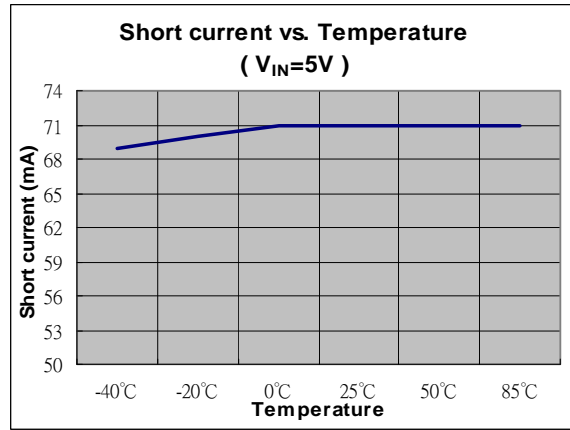
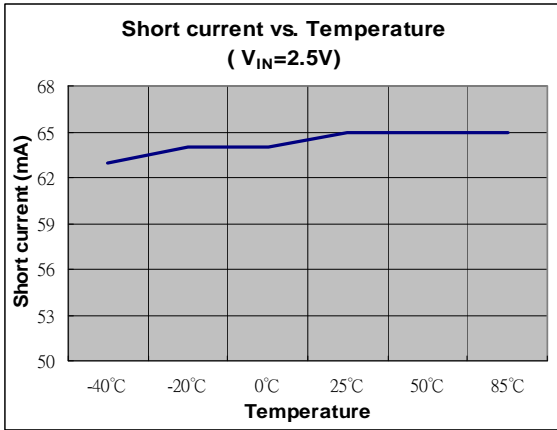

Typical Operating Characteristics (Continued)

Load Transient Response

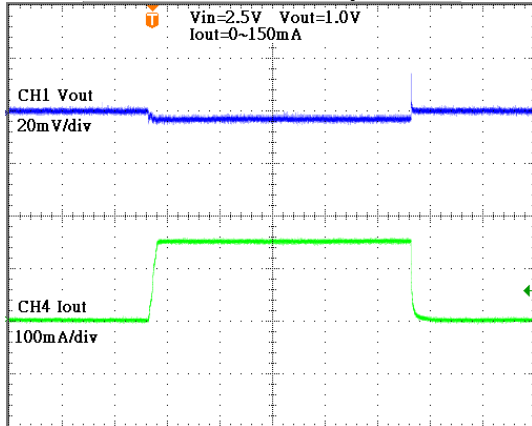

Load Transient Response

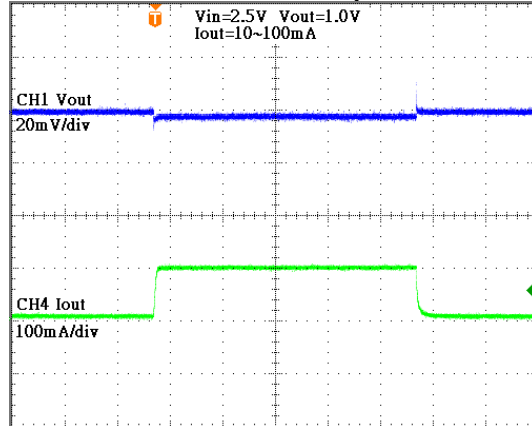

Start Up (EN vs. V_{OUT})

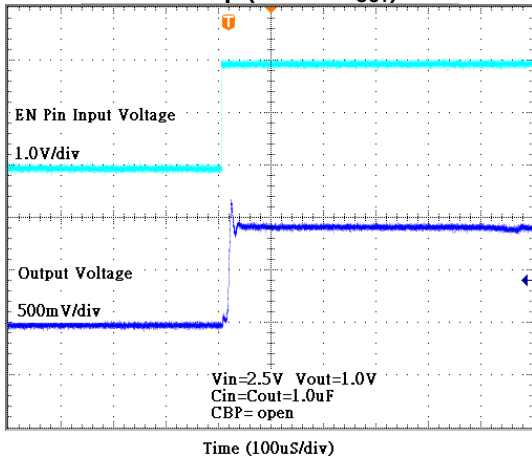

Start Up (EN vs. V_{OUT})

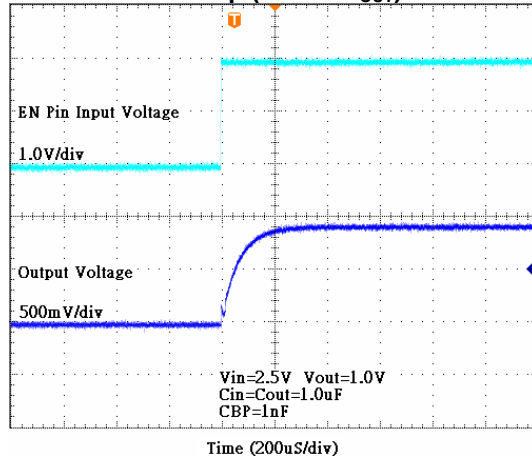

Start Up (EN vs. V_{OUT})

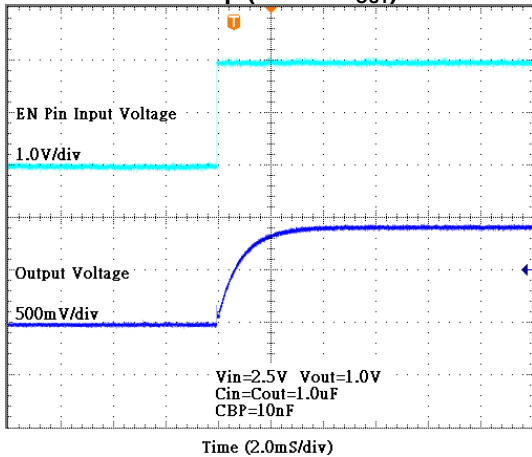

Start Up (EN vs. V_{OUT})

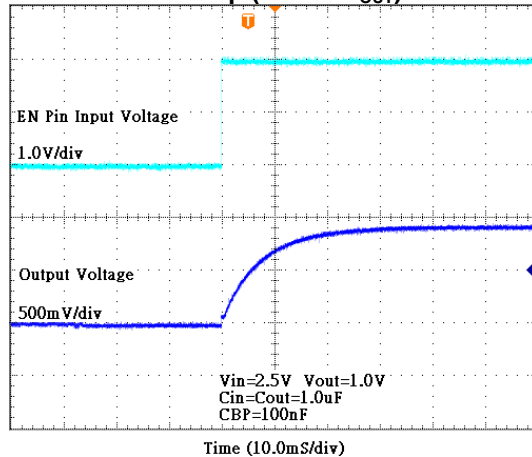

Application Note

■ **Input Capacitor**

An 1uF input capacitor is required between the AP7115 input pin and GND.

There are no requirements for the ESR on input capacitor, but tolerance and temperature coefficient must be considered.

■ **Output Capacitor**

The AP7115 can work with very small ceramic output capacitors (1uF or greater). Higher capacitance values help to improve transient. The output capacitor's ESR is critical because it from a zero to provide phase lead which is required for loop stability. Figure below is Cout ESR vs. Load Current.

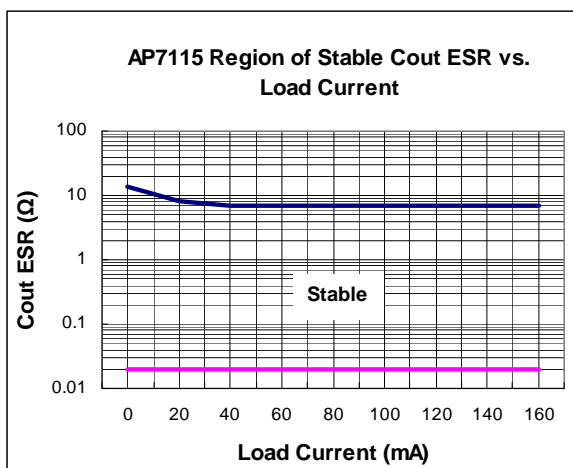

■ **Band-Gap Bypass Capacitor**

0.1uF bypass capacitor Between BP pin and GND can reduce output voltage noise.

■ **Shutdown Input Operation**

The AP7115 is shutdown by pulling the EN pin low, and turned on by driving the input high. If the shutdown feature is not required, the EN pin should be tied to VIN to keep the regulator on at all times.

■ **Dropout Voltage**

$$V_{\text{DROPOUT}} = V_{\text{IN}} - V_{\text{OUT}} = R_{\text{DS(ON)}} \times I_{\text{OUT}}$$

■ **Current Limit**

The AP7115 monitors and controls the PMOS' gate voltage, limiting the output current to 250mA(typ.). The output can be shorted to ground for an indefinite period of time without damaging the part.

■ **PCB Layout**

Optimum performance can only be achieved when the device is mounted on a PC board according to the diagram below:

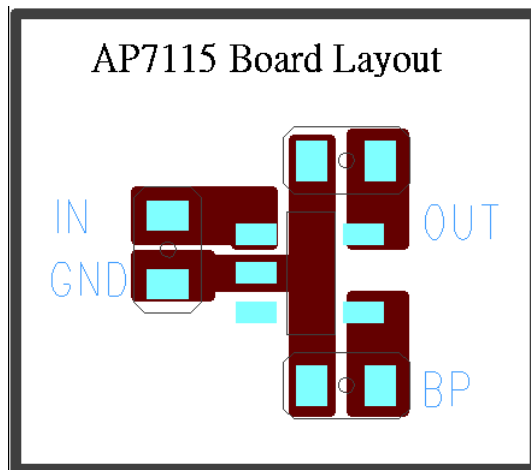

■ **Thermal Considerations**

Thermal Shutdown Protection limits power dissipation in AP7115. When the operation junction temperature exceeds 155°C, the Over Temperature Protection circuit starts the thermal shutdown function and turns the pass element off. The pass element turn on again after the junction temperature cools by 30°C. For continuous operation, do not exceed absolute maximum operation junction temperature 125°C. The power dissipation definition in device is:

$$P_D = (V_{\text{IN}} - V_{\text{OUT}}) \times I_{\text{OUT}} + V_{\text{IN}} \times I_Q$$

The maximum power dissipation depends on the thermal resistance of IC package, PCB layout, the rate of surroundings airflow and temperature difference between junction to ambient. The maximum power dissipation can be calculated by the following formula:

$$P_{D(\text{MAX})} = (T_{J(\text{MAX})} - T_A) / \theta_{JA}$$

Where $T_{J(\text{MAX})}$ is the maximum operation junction temperature 125°C, T_A is the ambient temperature and the θ_{JA} is the junction to ambient thermal resistance.

Marking Information

(Top View)

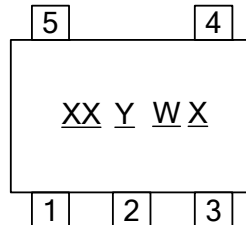

XX : Identification code
Y : Year 0~9
W : Week : A~Z : 1~26 week;
 a~z : 27~52 week; z represents
 52 and 53 week
X : A~Z : Green

Part Number	Identification Code	Part Number	Identification Code
SOT25		SOT353	
AP7115-10W	FO	AP7115-10SE	GO
AP7115-12W	FP	AP7115-12SE	GP
AP7115-15W	FQ	AP7115-15SE	GQ
AP7115-18W	FR	AP7115-18SE	GR
AP7115-25W	FS	AP7115-25SE	GS
AP7115-28W	FT	AP7115-28SE	GT
AP7115-29W	FU	AP7115-29SE	GU
AP7115-30W	FV	AP7115-30SE	GV
AP7115-33W	FW	AP7115-33SE	GW
AP7115-35W	FX	AP7115-35SE	GX

Package Information (All Dimensions in mm)

(1) Package Type: SOT25

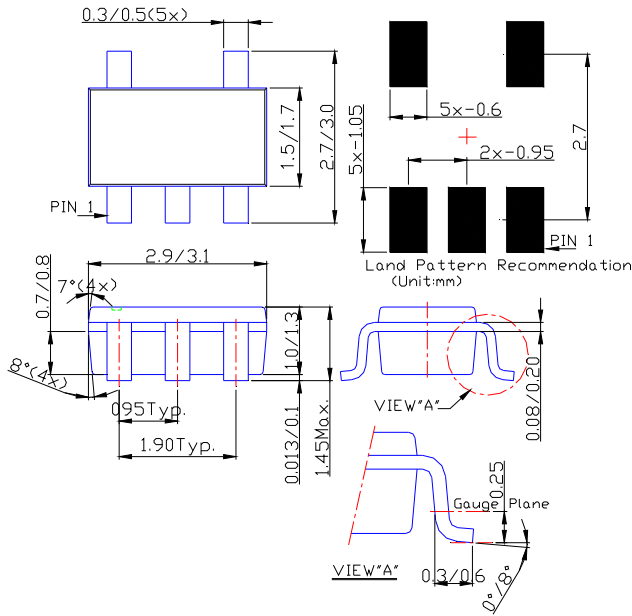

(2) Package Type: SOT353

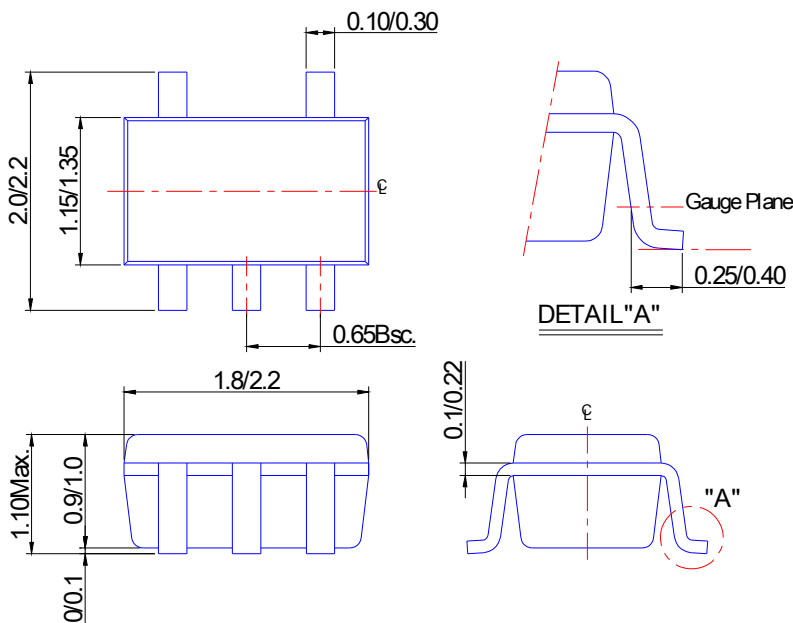

IMPORTANT NOTICE

DIODES INCORPORATED MAKES NO WARRANTY OF ANY KIND, EXPRESS OR IMPLIED, WITH REGARDS TO THIS DOCUMENT, INCLUDING, BUT NOT LIMITED TO, THE IMPLIED WARRANTIES OF MERCHANTABILITY AND FITNESS FOR A PARTICULAR PURPOSE (AND THEIR EQUIVALENTS UNDER THE LAWS OF ANY JURISDICTION).

Diodes Incorporated and its subsidiaries reserve the right to make modifications, enhancements, improvements, corrections or other changes without further notice to this document and any product described herein. Diodes Incorporated does not assume any liability arising out of the application or use of this document or any product described herein; neither does Diodes Incorporated convey any license under its patent or trademark rights, nor the rights of others. Any Customer or user of this document or products described herein in such applications shall assume all risks of such use and will agree to hold Diodes Incorporated and all the companies whose products are represented on Diodes Incorporated website, harmless against all damages.

Diodes Incorporated does not warrant or accept any liability whatsoever in respect of any products purchased through unauthorized sales channel.

Should Customers purchase or use Diodes Incorporated products for any unintended or unauthorized application, Customers shall indemnify and hold Diodes Incorporated and its representatives harmless against all claims, damages, expenses, and attorney fees arising out of, directly or indirectly, any claim of personal injury or death associated with such unintended or unauthorized application.

Products described herein may be covered by one or more United States, international or foreign patents pending. Product names and markings noted herein may also be covered by one or more United States, international or foreign trademarks.

LIFE SUPPORT

Diodes Incorporated products are specifically not authorized for use as critical components in life support devices or systems without the express written approval of the Chief Executive Officer of Diodes Incorporated. As used herein:

A. Life support devices or systems are devices or systems which:

1. are intended to implant into the body, or
2. support or sustain life and whose failure to perform when properly used in accordance with instructions for use provided in the labeling can be reasonably expected to result in significant injury to the user.

B. A critical component is any component in a life support device or system whose failure to perform can be reasonably expected to cause the failure of the life support device or to affect its safety or effectiveness.

Customers represent that they have all necessary expertise in the safety and regulatory ramifications of their life support devices or systems, and acknowledge and agree that they are solely responsible for all legal, regulatory and safety-related requirements concerning their products and any use of Diodes Incorporated products in such safety-critical, life support devices or systems, notwithstanding any devices- or systems-related information or support that may be provided by Diodes Incorporated. Further, Customers must fully indemnify Diodes Incorporated and its representatives against any damages arising out of the use of Diodes Incorporated products in such safety-critical, life support devices or systems.

Copyright © 2009, Diodes Incorporated

www.diodes.com

AMEYA360

Components Supply Platform

Authorized Distribution Brand :



Website :

Welcome to visit www.ameya360.com

Contact Us :

➤ Address :

401 Building No.5, JiuGe Business Center, Lane 2301, Yishan Rd
Minhang District, Shanghai , China

➤ Sales :

Direct +86 (21) 6401-6692

Email amall@ameya360.com

QQ 800077892

Skype [ameyasales1](#) [ameyasales2](#)

➤ Customer Service :

Email service@ameya360.com

➤ Partnership :

Tel +86 (21) 64016692-8333

Email mkt@ameya360.com